

Briggs & Stratton OPERATING AND MAINTENANCE INSTRUCTIONS

MODELS 23A, 23A-B, 23A-FB 23A-R6, 23A-R6D

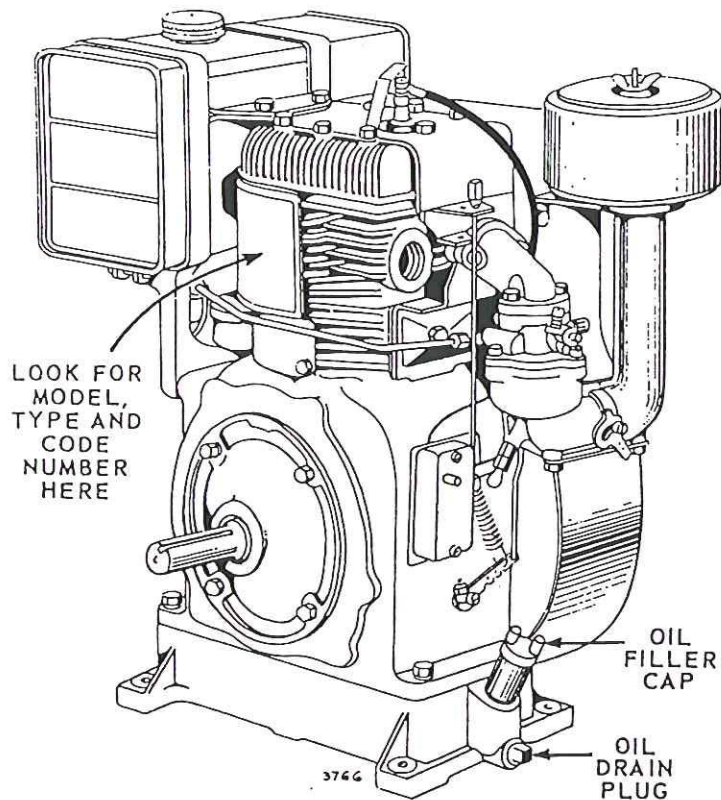

IMPORTANT: Do not start this engine before reading Section I and Section II of this manual.

CAUTION

PROVIDE EFFICIENT VENTILATION. Exhaust gases contain carbon monoxide, an odorless and deadly poison. Do not operate engine in an enclosed area.

KEEP ENGINE CLEAN. This engine is air-cooled. If cooling system becomes clogged, serious damage may result. Therefore, keep the blower screen, fins on flywheel, cylinder head and block free from grass or dirt.

SECTION I

BEFORE STARTING

FILL FUEL TANK

Use clean, fresh "regular" grade gasoline.

CAUTION: The use of old or stale gasoline will result in gum deposits clogging the fuel system and carburetor. Make sure that vent hole in the tank cap is open.

DO NOT MIX OIL WITH GASOLINE.

LUBRICATION RECOMMENDATIONS

Any high quality detergent oil bearing the American Petroleum Institute Classification "For Service MS" can be used in your Briggs & Stratton engine. Detergent oils keep the engine cleaner and retard the formation of gum and varnish deposits.

WINTER

(Below 40° F.)
Use SAE 5W-20
If not Available
Use SAE 10W
Above 10° F.

SUMMER

(Above 40° F.)
Use SAE 30
If not Available
Use SAE 10W-30

Nothing should be added to the recommended oils.

FORM NO. 27760 - 94
PRINTED IN U.S.A.

FILL CRANKCASE WITH OIL

The oil filler cap is located at the end of engine base. To open, use a screwdriver or bar as illustrated. With the engine standing level, pour oil in opening until it rises to the top of filler cap opening. Be sure oil stays at top level before replacing cap. Oil capacity is 4 pints.

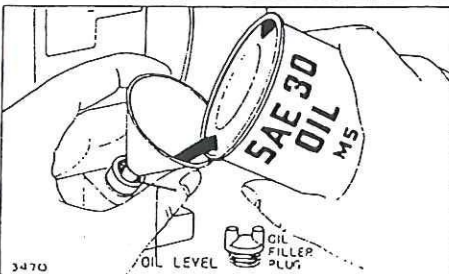
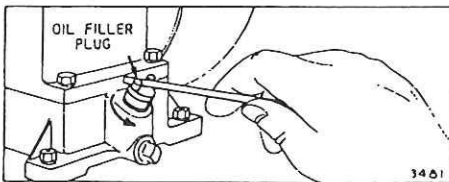

"OIL-FOAM"® AIR CLEANER

"Oil-Foam"® air cleaners are oiled at the factory and do not require initial service.

FILL OIL BATH AIR CLEANER

Oil bath air cleaners must be filled before operating engine. Use same grade oil as in crankcase.

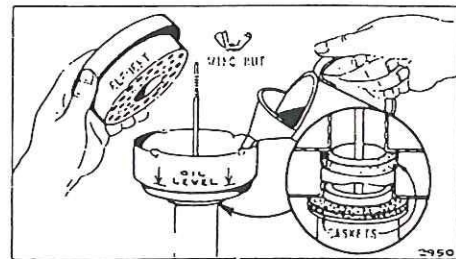

Remove wing nut. Lift out filter element. Lift off bowl. Pour oil in small bottom part of bowl to "oil level" mark at end of arrows. Replace bowl, element, and wing nut. Be sure gaskets are in place.

BRIGGS & STRATTON CORP.
Milwaukee, Wisconsin 53201



IMPORTANT SAFETY INFORMATION AND INSTRUCTIONS FOR ENGINE SELECTION ENGINE INSTALLATION ENGINE OPERATION

In the USA and Canada,
our 24 hour hotline is:

18002333723

Briggs & Stratton Corporation
Milwaukee, Wisconsin 53201

www.briggsandstratton.com

Keep these instructions for future reference.

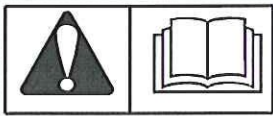



Before installing and operating this engine read and observe all warnings, cautions and instructions on both sides of this sheet, on the engine, and in the operating & maintenance instructions.

NOTE: This sheet of instructions and safety information is not meant to cover all possible conditions and situations that may occur. Read entire Operating & Maintenance Instructions for this engine AND the instructions for the equipment this engine powers. Failure to follow instructions and safety information could result in serious injury or death.

The safety alert symbol () is used to identify safety information about hazards that can result in personal injury.

A signal word (DANGER, WARNING, or CAUTION) is used with the alert symbol to indicate the likelihood and the potential severity of injury. In addition, a hazard symbol may be used to represent the type of hazard.

 **DANGER** indicates a hazard which, if not avoided, will result in death or serious injury.

 **WARNING** indicates a hazard which, if not avoided, could result in death or serious injury.

 **CAUTION** indicates a hazard which, if not avoided, might result in minor or moderate injury.

CAUTION, when used **without** the alert symbol, indicates a situation that could result in damage to the engine.

HAZARD SYMBOLS AND MEANINGS



Fire



Explosion



Moving Parts



Toxic Fumes



Hot Surface



Shock



Kickback

(OVER)

FORM MS-6445-01/03







ENGINE SELECTION









 WARNING

Failure to select the correct engine could result in fire or explosion.







- Some engines are unique and designed for specific applications or types of equipment. If this engine will be used to build new equipment, contact Briggs & Stratton to ensure that the engine is appropriate for the intended use.
Note: For all Go-karts use only a model 136200 series engine, which offers improved safety and performance.
- Replacement engines should be the same model as the original engine, or be the Briggs & Stratton designated replacement engine. Refer to the Operation & Maintenance Instructions for engine identification information.
Note: For all Go-karts use only a model 136200 series engine, which offers improved safety and performance.
- Do not use Briggs & Stratton engines on 3-wheel All-Terrain Vehicles (ATVs), motor bikes, air craft products, or vehicles intended for use in competitive events. Briggs & Stratton does not approve of or authorize such uses.

ENGINE INSTALLATION

- Do not attempt to install this engine if you do not have the appropriate tools and knowledge of small engine installation procedures. Use only Briggs & Stratton parts. Contact your Authorized Service Dealer for assistance.
- Do not modify the engine in any way without Briggs & Stratton factory approval. Any such modification is at the owner's sole risk.
- If the exhaust system on the old engine was supplied by the equipment manufacturer, you must transfer the exhaust system and related components (original muffler and related pipes, brackets, clamps, and shields) to the new engine. All components must be in good condition.
- | | |
|--|---|
|  WARNING | Install muffler (and muffler deflector if used) so outlet points away from operator, fuel tank, and equipment, and so muffler heat will not damage or deform engine and components. |
|  | |
- | | |
|--|--|
|  WARNING | Ensure all fuel lines and fittings are properly assembled and do not leak. Replacement parts must be the same model as the original. |
|  | |
- | | |
|--|--|
|  WARNING | Ensure all wiring, including safety switches and engine shut-off components are completely installed and functioning properly. |
|  | |
- Set engine speed to equipment manufacturer's specification. Refer to equipment manufacturer's manual. Do not tamper with governor springs, or other parts that will increase engine speed above specification.

- | | |
|--|--|
|  WARNING | All engine parts, including fuel cap, spark plug, muffler, air cleaner, and covers and guards for drive components (gears, belts, shafts, couplings, etc.) must be in place before attempting to start engine. |
|  | |
- | | |
|--|---|
|  WARNING | If engine is installed on walk behind lawn mower, all mower components, including cutting blade, must be correctly installed before attempting to start engine. |
|  | |
- | | |
|--|---|
|  WARNING | When working on the engine or equipment, remove spark plug wire from spark plug. For electric start, remove negative wire from battery. |
|  | |
- | | |
|--|--|
|  WARNING | Do not check for spark with spark plug removed. Use Briggs & Stratton spark tester #19368. |
|  | |

ENGINE OPERATION

	 WARNING
	When adding fuel:
Turn engine off and let engine cool at least 2 minutes before removing gas cap. Fill fuel tank outdoors or in well-ventilated area. Fill tank to about 1 inch below lowest portion of neck to allow for fuel expansion. Keep gasoline away from sparks, open flames, pilot lights, heat, and other ignition sources.	
	 WARNING
	When starting engine:
Remove all external equipment/engine loads. Wait until spilled fuel is evaporated. Start engine outdoors. Pull cord slowly until resistance is felt, then pull rapidly. If engine floods, set choke to OPEN/RUN, place throttle in FAST and crank until engine starts.	
	 WARNING
	When operating equipment:
Do not tip engine or equipment at angle which causes gasoline to spill. Run engine outdoors. Do not run in enclosed area, even if doors or windows are open. Do not choke carburetor to stop engine.	

SECTION II STARTING

TO START ENGINE

1. Open Fuel Valve

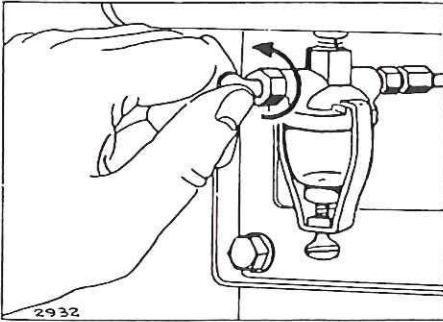

2. Close the Choke

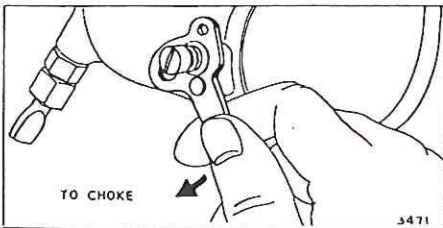

3. Start Engine

a. Rope Starter

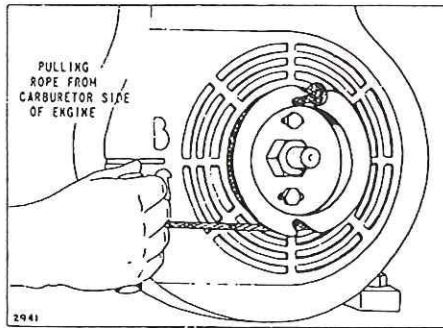

Place knot in pulley notch and wind rope around pulley in a clockwise direction. Pull rope with choke closed to prime the engine. Open choke slightly and repeat operation.

After engine warms up open choke gradually until engine runs smoothly with choke wide open (counterclockwise position).

b. 12 Volt D.C. Electric Starter

Press starter button on powered

equipment. When engine starts, open choke gradually.

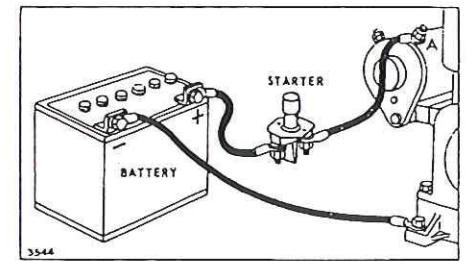

4. To Stop Engine

Press the red stop button located on the breaker box. Hold button down until engine stops.

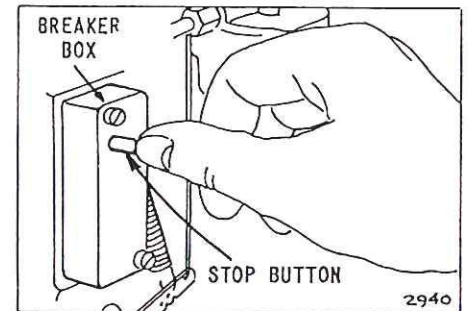

SECTION III REGULAR MAINTENANCE

Clean and re-oil the air cleaner frequently (every few hours under extremely dusty conditions). Clean and re-oil at least every 25 hours under normal conditions.

OIL BATH TYPE

Remove wing nut, lift out upper element and remove bowl containing oil.

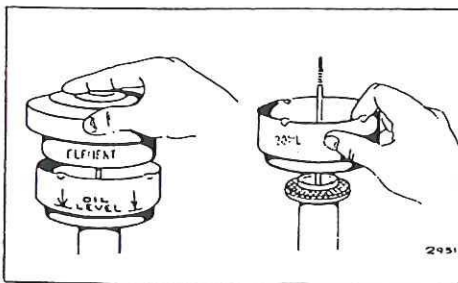

Pour out old oil. Wash the filter element in kerosene or gasoline and shake dry. Clean bowl, wipe dry. Pour oil in small bottom part of bowl to "oil level" mark shown at end of arrows. Replace bowl. Replace filter element and wing nut. Be sure gaskets are in place.

OIL FOAM® TYPE

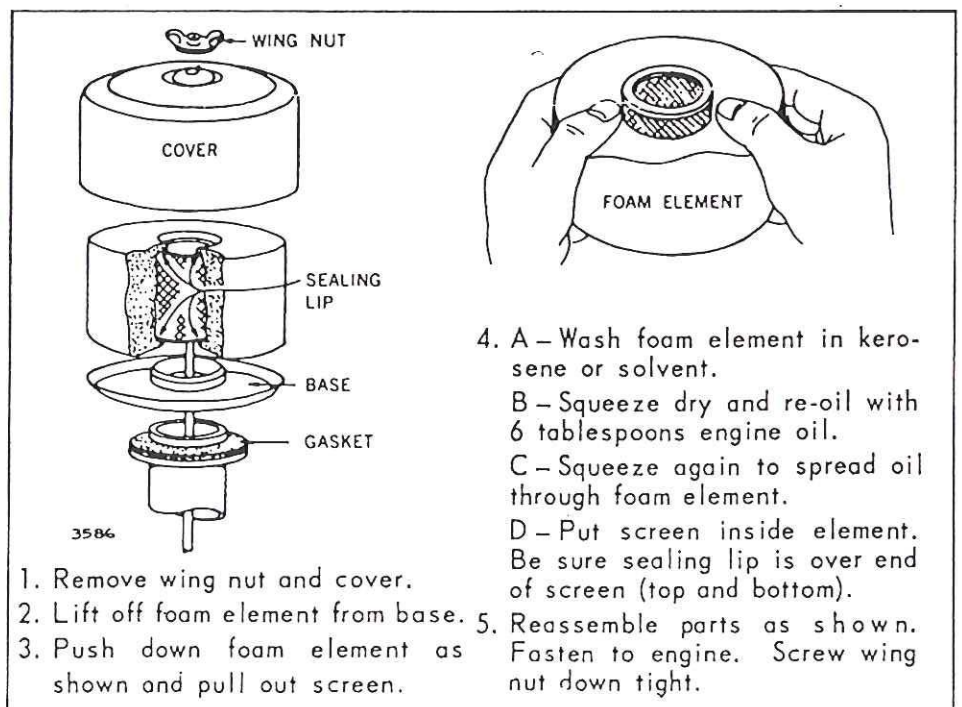

1. Remove wing nut and cover.
2. Lift off foam element from base.
3. Push down foam element as shown and pull out screen.
4. A - Wash foam element in kerosene or solvent.
- B - Squeeze dry and re-oil with 6 tablespoons engine oil.
- C - Squeeze again to spread oil through foam element.
- D - Put screen inside element. Be sure sealing lip is over end of screen (top and bottom).
5. Reassemble parts as shown. Fasten to engine. Screw wing nut down tight.

CHANGE OIL (Crankcase)

Change oil after 5 hours of operation. Remove the oil drain plug. Drain oil while engine is warm. Replace drain plug. Remove oil filler cap or plug and refill with new oil. Replace oil filler cap or plug. Add oil regularly after each 5 hours of operation. Thereafter change oil every 25 hours of operation.

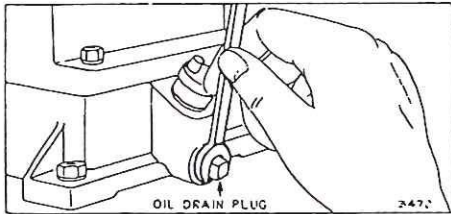

CHANGE OIL (Gear Reduction)

The reduction gears are lubricated by engine crankcase oil. Remove drain plug from gear case cover to drain oil remaining in gear case when crankcase oil is changed.

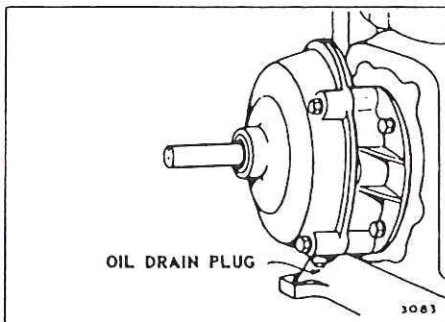

DRAINING FUEL TANK AND CLEANING FUEL FILTER

Loosen thumb screw below filter bowl.

Remove and clean filter bowl and screen.

Open shut-off valve to see if fuel flows freely from the tank. **IMPORTANT:** If you find a gummy, varnish-like substance use alcohol or acetone to dissolve it.

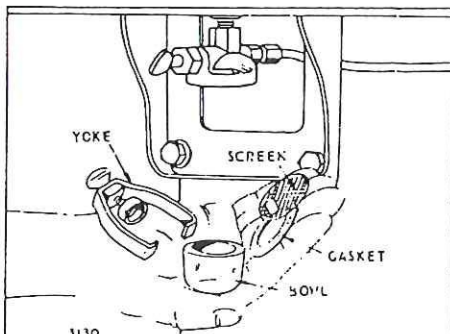

TO CHECK SPARK PLUG GAP

Clean spark plug and reset gap at .025" every 100 hours of operation. When worn out replace with AC GC 46, Autolite A71 or Champion J-8. Size 14 mm.

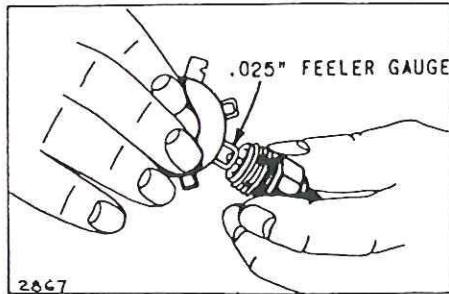

CLEAN COOLING SYSTEM

Grass or chaff may clog cooling system after prolonged service in cutting tall dry grasses or hay. Continued operation with a clogged cooling system causes severe overheating and possible engine damage. Remove blower housing and clean regularly.

TO CLEAN AND ADJUST CONTACT POINTS

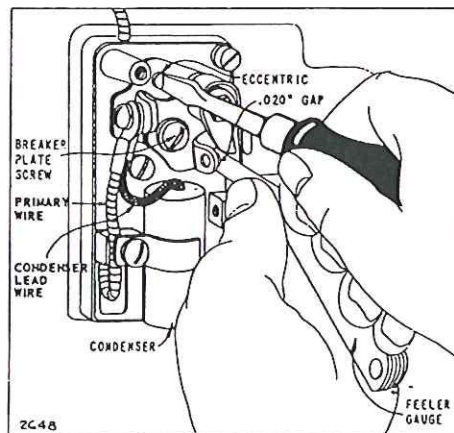

Remove cover.

Clean points with a carborundum contact point stone. Then insert a hard finished card or piece of paper and close and open points. The paper will absorb any dirt or filings on the points. Adjust breaker points as follows:

- a. Rotate crankshaft until points open to widest gap.
- b. Loosen breaker plate screw slightly.

- c. Rotate eccentric to obtain .020" gap.
- d. Tighten breaker plate screw.
- e. Replace breaker box cover.

CLEAN COMBUSTION CHAMBER EVERY 100-300 HOURS OF OPERATION

This industrial engine generally operates at constant speed and at relatively constant load. The use of regular automotive fuels under these conditions results in a gradual build-up of tetra-ethyl lead deposits in the combustion chamber.

This causes the engine to lose power and prevents the valves from seating properly. Removing the deposits is easy and will pay big dividends in reliability and increased valve life.

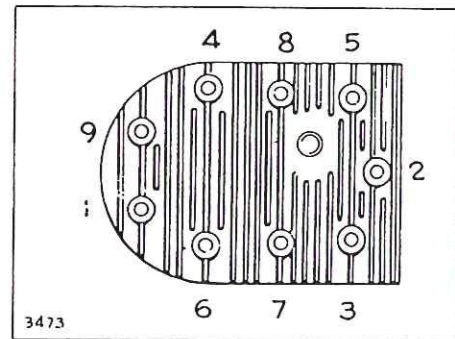

1. Remove cylinder head screws. Be sure to note if screws are of different length and have steel washers as they must be replaced in original position.
2. Turn crankshaft until piston is at top of cylinder bore and both valves are closed. Scrape and wire brush the lead and carbon deposits from cylinder head and combustion chamber.
3. Re-use cylinder head gasket only if in good condition. Replace cylinder head. Turn each screw in with wrench until screw head is lightly seated.
4. Use socket wrench with 6 inch handle and turn all screws 1.4 turn. Tighten screws in sequence illustrated. Run engine approximately 5 minutes and re-tighten all screws approximately 1.4 turn.

SECTION IV ADJUSTMENTS

CARBURETOR ADJUSTMENTS

Initial Adjustment

Turn needle valve clockwise until it just closes: **CAUTION:** Valve may be damaged by turning it in too far.

Now open needle valve 1-1/2 turns counterclockwise.

Close idle valve in same manner and open it 1/2 to 3/4 turns. This initial adjustment will permit the engine to be started and warmed up prior to final adjustment.

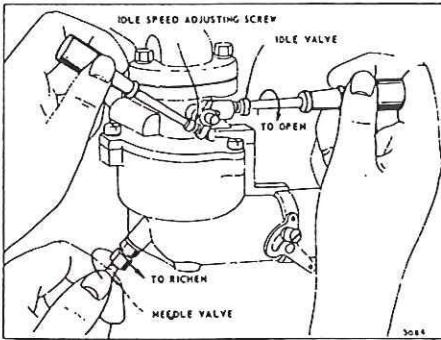

Final Adjustment

Turn needle valve in until engine misses (lean mixture), then turn it out past smooth operating point until engine runs unevenly (rich mixture). Now turn needle valve to the mid-point between rich and lean so the engine runs smoothly.

Hold throttle at idle position, set idle speed adjusting screw until fast idle is obtained (1200 RPM). Hold throttle in idle position and turn idle valve in (lean) and out (rich) until engine idles smoothly. Then reset idle speed so that engine idles at 1200 RPM. Release throttle—engine should accelerate without hesitation or sputtering. If engine does not accelerate properly, re-adjust carburetor to a slightly richer mixture.

GOVERNOR ADJUSTMENTS

The correct operating speed range is 1800 to 3600 RPM. The standard speed setting (no load) is 2900 RPM. Idle speed is 1200 RPM.

Thumb Nut Adjustment

To increase speed, turn nut (clockwise) or move lower end of governor spring farther away from governor lever shaft.

To reduce speed, turn nut counterclockwise) or move lower end of spring closer to governor lever shaft.

If the speed of the engine is not steady although the carburetor has been properly adjusted, move the spring farther away from the governor lever shaft.

If the speed variation between no load and full load is too great, move spring closer to governor lever shaft.

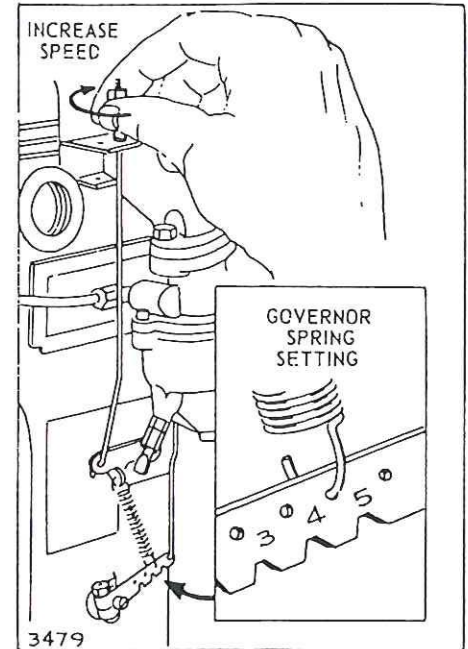

REMOTE GOVERNOR CONTROL

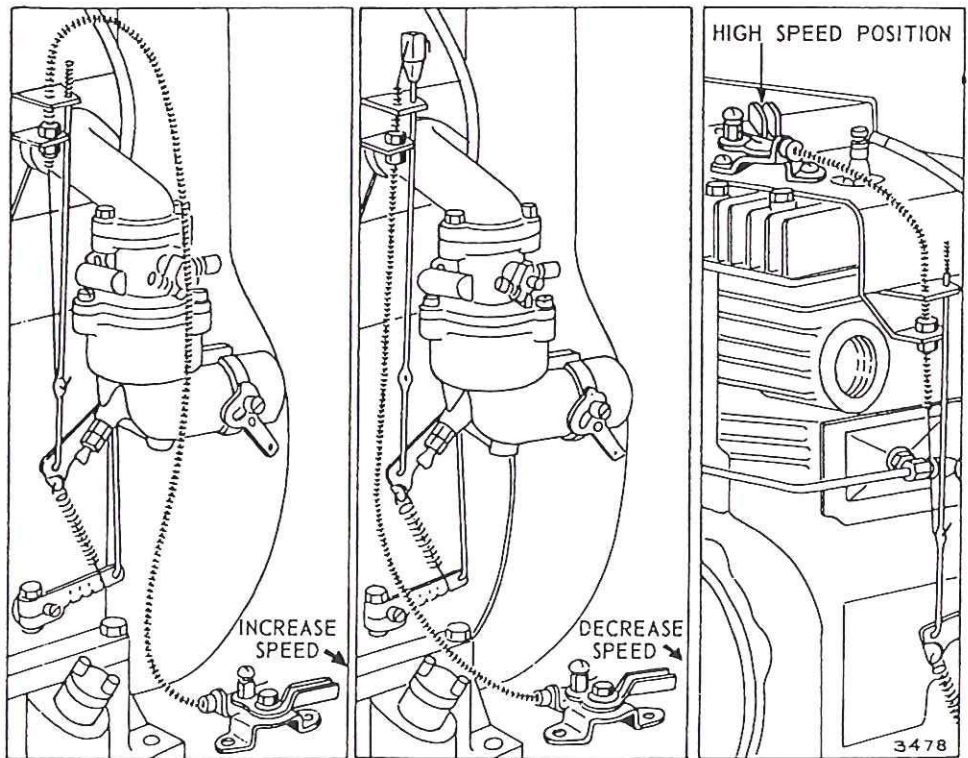

Engine speed is controlled by movement of the control lever. To adjust: Move control lever to HIGH speed position. Loosen screw on swivel. Move wire through swivel until desired operating speed is obtained. Retighten swivel screw, bend loose end of wire around swivel. Cut off excess wire. Be sure to remove or loosen thumb screw on governor control rod.

SECTION V
GENERAL INFORMATION

These engines are single cylinder, L-Head, air-cooled type

Bore - 3"; Stroke - 3¼"; Displacement - 22.97 cu. in.; Horsepower: -

5.27 h.p. at 1800 r.p.m. 8.63 h.p. at 3000 r.p.m.

7.21 h.p. at 2400 r.p.m. 9.00 h.p. at 3600 r.p.m.

Torque (Ft. Lbs. 15.75 at 2400 RPM

Intake Valve Clearance.007"-.009"

Exhaust Valve Clearance . . .017"-.019"

The horsepower ratings listed above are established by standard I.C.E.I. procedures. For practical operation, the horsepower loading should not exceed 85% of these ratings. Engine power will decrease 3½% for each 1,000 ft. above sea level and 1% for each 10 degrees above 60 degrees F.

Major engine repairs should not be attempted unless you have the proper tools and a thorough knowledge of internal combustion engines.

STORAGE INSTRUCTIONS

Engines stored for over 30 days should be completely drained of fuel to prevent gum deposits forming on essential carburetor parts, fuel filter, fuel lines and tank.

- a. Remove filter bowl, open shut-off valve and drain tank completely.
- b. Replace filter bowl. Leave fuel valve open.
- c. Operate engine until it stops from lack of fuel.
- d. While engine is still warm, drain and clean the oil sump. Refill with fresh oil.
- e. Remove spark plug, pour one ounce of SAE 30 oil into cylinder and crank slowly to spread oil. Replace spark plug.
- f. Clean dirt and chaff from cylinder, cylinder head fins and blower housing.

Briggs & Stratton's policy of continual product improvement is evidenced by the many patents issued to the corporation covering engine improvements, some of which are listed below.

2,431,329	2,510,825	2,564,787	2,693,789	2,717,916	2,954,506	3,040,853
2,438,585	2,529,242	2,573,116	2,693,791	2,781,280	2,999,489	3,044,238
2,459,428	2,529,243	2,605,753	2,696,577	2,796,453	2,999,491	3,044,239
2,491,070	2,529,244	2,649,488	2,699,636	2,796,454	2,999,562	3,114,851
2,496,688	2,548,334	2,669,322	2,717,589	2,908,263	3,028,848	3,118,433

DESIGN PATENTS

173,072

191,806

SECTION VI
WARRANTY

SAVE THIS INFORMATION FOR YOUR OWN RECORD

BRIGGS & STRATTON ENGINE WARRANTY

For ONE YEAR from purchase date, Briggs & Stratton Corp. will replace for the original purchaser, FREE OF CHARGE, any part, or parts, found upon examination by any Factory Authorized Service Outlet, or by the Factory at Milwaukee, Wisconsin, to be DEFECTIVE IN MATERIAL AND/OR WORKMANSHIP.

All transportation charges on parts submitted for replacement under this Warranty must be borne by purchaser.

There is no other Warranty express or implied. Briggs & Stratton Corp. shall in no event be liable for consequential damages.

BRIGGS & STRATTON CORP.

C. L. COUGHLIN - PRESIDENT

NOTE: The Briggs & Stratton Engine Warranty does not cover breakage of parts or damage to parts due to abuse or failure to follow recommended regular maintenance of crankcase oil level, cleaning of air cleaner and engine cooling fins, nor does it warrant any accessories, controls or equipment not of our manufacture.

Engine Model No. _____)
Engine Type No. _____) See Illustration on Page 1 to locate Model,
Engine Code No. _____) Type and Code Number.
Date Purchased _____)
Dealer Purchased from _____
Type of Equipment _____
Name or Trademark of Equipment Manufacturer _____

NO REGISTRATION (WARRANTY) CARD IS NECESSARY IN ORDER TO OBTAIN WARRANTY ON BRIGGS & STRATTON ENGINES

In case warranty service is ever needed you should present the above information to the nearest Authorized Service Dealer. You will need to give a complete report on the trouble experienced and the number of hours the engine has run since the equipment was purchased.

If you differ with the decision of a Service Dealer on a warranty claim, the Dealer's terms should be accepted. The Dealer will submit all supporting facts to the factory for review. If the factory's decision is that your claim is justified, you will be fully reimbursed for those items accepted as defective.

◆ ◆ ◆ ◆ ◆ ◆ ◆ ◆
For replacement parts or service, only the Model, Type and Code numbers are needed by the Authorized Service Dealer.

NATION WIDE SERVICE ORGANIZATION

Briggs & Stratton maintains a vast network of Authorized Service Dealers that are prepared to give you prompt and efficient engine service.

Each member of this organization carries a stock of original Briggs & Stratton repair parts and is equipped with special service tools. Trained mechanics assure expert repair service on all Briggs & Stratton engines.

See yellow pages of your Classified Telephone Directory for nearby engine service under heading -- "Engines Gasoline" or "Gasoline Engines".

