

INSTRUCTIONS
for Type "FG" Fullpower
Briggs-Stratton Engine

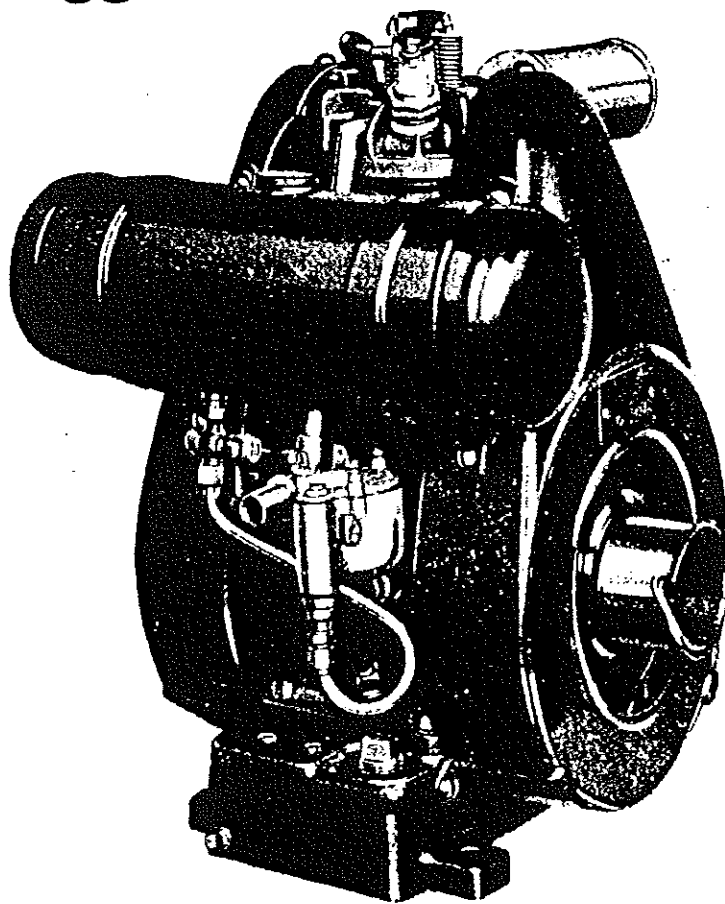

BRIGGS & STRATTON CORP.

MILWAUKEE



WISCONSIN

IMPORTANT SAFETY INFORMATION AND INSTRUCTIONS FOR ENGINE SELECTION ENGINE INSTALLATION ENGINE OPERATION

In the USA and Canada,
our 24 hour hotline is:
18002333723
Briggs & Stratton Corporation
Milwaukee, Wisconsin 53201
www.briggsandstratton.com

Keep these instructions for future reference.

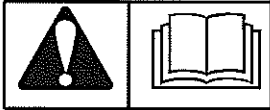



Before installing and operating this engine read and observe all warnings, cautions and instructions on both sides of this sheet, on the engine, and in the operating & maintenance instructions.

NOTE: This sheet of instructions and safety information is not meant to cover all possible conditions and situations that may occur. Read entire Operating & Maintenance Instructions for this engine AND the instructions for the equipment this engine powers. Failure to follow instructions and safety information could result in serious injury or death.

The safety alert symbol () is used to identify safety information about hazards that can result in personal injury.

A signal word (DANGER, WARNING, or CAUTION) is used with the alert symbol to indicate the likelihood and the potential severity of injury. In addition, a hazard symbol may be used to represent the type of hazard.



 **DANGER** indicates a hazard which, if not avoided, will result in death or serious injury.

 **WARNING** indicates a hazard which, if not avoided, could result in death or serious injury.

 **CAUTION** indicates a hazard which, if not avoided, might result in minor or moderate injury.

CAUTION, when used **without** the alert symbol, indicates a situation that **could result in damage to the engine.**

HAZARD SYMBOLS AND MEANINGS

 Fire	 Explosion	 Moving Parts
 Toxic Fumes	 Hot Surface	 Shock
 Kickback		

(OVER)



ENGINE SELECTION



 WARNING
 
Failure to select the correct engine could result in fire or explosion.



- Some engines are unique and designed for specific applications or types of equipment. If this engine will be used to build new equipment, contact Briggs & Stratton to ensure that the engine is appropriate for the intended use.
Note: For all Go-karts use only a model 136200 series engine, which offers improved safety and performance.
- Replacement engines should be the same model as the original engine, or be the Briggs & Stratton designated replacement engine. Refer to the Operation & Maintenance Instructions for engine identification information.
Note: For all Go-karts use only a model 136200 series engine, which offers improved safety and performance.
- Do not use Briggs & Stratton engines on 3-wheel All-Terrain Vehicles (ATVs), motor bikes, air craft products, or vehicles intended for use in competitive events. Briggs & Stratton does not approve of or authorize such uses.

ENGINE INSTALLATION



- [1] Do not attempt to install this engine if you do not have the appropriate tools and knowledge of small engine installation procedures. Use only Briggs & Stratton parts. Contact your Authorized Service Dealer for assistance.
- [2] Do not modify the engine in any way without Briggs & Stratton factory approval. Any such modification is at the owner's sole risk.
- [3] If the exhaust system on the old engine was supplied by the equipment manufacturer, you must transfer the exhaust system and related components (original muffler and related pipes, brackets, clamps, and shields) to the new engine. All components must be in good condition.
- [4]



 WARNING	Install muffler (and muffler deflector if used) so outlet points away from operator, fuel tank, and equipment, and so muffler heat will not damage or deform engine and components.
	
- [5]



 WARNING	Ensure all fuel lines and fittings are properly assembled and do not leak. Replacement parts must be the same model as the original.
 	
- [6]



 WARNING	Ensure all wiring, including safety switches and engine shut-off components are completely installed and functioning properly.
 	
- [7] Set engine speed to equipment manufacturer's specification. Refer to equipment manufacturer's manual. Do not tamper with governor springs, or other parts that will increase engine speed above specification.

- [8]











 WARNING	All engine parts, including fuel cap, spark plug, muffler, air cleaner, and covers and guards for drive components (gears, belts, shafts, couplings, etc.) must be in place before attempting to start engine.
 	
- [9]

 WARNING	If engine is installed on walk behind lawn mower, all mower components, including cutting blade, must be correctly installed before attempting to start engine.
	
- [10]

 WARNING	When working on the engine or equipment, remove spark plug wire from spark plug. For electric start, remove negative wire from battery.
 	
- [11]

 WARNING	Do not check for spark with spark plug removed. Use Briggs & Stratton spark tester #19368.
	

ENGINE OPERATION

 	 WARNING
	When adding fuel:
<p>Turn engine off and let engine cool at least 2 minutes before removing gas cap.</p> <p>Fill fuel tank outdoors or in well-ventilated area. Fill tank to about 1 inch below lowest portion of neck to allow for fuel expansion.</p> <p>Keep gasoline away from sparks, open flames, pilot lights, heat, and other ignition sources.</p>	
  	 WARNING
	When starting engine:
<p>Remove all external equipment/engine loads.</p> <p>Wait until spilled fuel is evaporated. Start engine outdoors.</p> <p>Pull cord slowly until resistance is felt, then pull rapidly.</p> <p>If engine floods, set choke to OPEN/RUN, place throttle in FAST and crank until engine starts.</p>	
 	 WARNING
	When operating equipment:
<p>Do not tip engine or equipment at angle which causes gasoline to spill.</p> <p>Run engine outdoors. Do not run in enclosed area, even if doors or windows are open.</p> <p>Do not choke carburetor to stop engine.</p>	

INDEX TO CONTENTS

	Page
Carburetor	12
Compression, Lack of	14
Cylinder Head	15
Cylinder Scored	17
Engine Fails To Start	9
Engine, Illustrated	1-4
Engine Knocks	11
Filling	7
Guarantee	3
Ignition	12
Inspection	6
Instructions For Use	3
Lubrication	7
Operation and Care	20
Ordering Parts	21
Parts, Description of	21
Parts of Engine, Illustrated	25
Parts of Magneto, Illustrated	27
Parts Price List	23
Piston Rings, Worn	17
Prices	27
Remittance	22
Repairs	21
Return Material	22
Shipping Instructions	22
Speed Regulation	17
Starting Engine	9
Stopping Engine	2
Timing	19
Timing Diagram	1
Troubles and Remedies	
Valves	

IMPORTANT—Please Read This Carefully

It is important that the instructions in this booklet be read and followed in order to insure satisfactory operation of the engine.

When desiring additional information, returning material or placing parts orders, address your letter to the attention of the Service Department. In replying to a letter from the company please mention the name of the individual and date of the letter but address the letter to the company and not to an individual.

WHEN ORDERING PARTS OR WRITING TO US ABOUT THIS ENGINE ALWAYS BE SURE TO GIVE THE NUMBER AND TYPE LETTER PRECEDING THE NUMBER. THIS NUMBER WILL BE FOUND ON THE NAME PLATE RIVETED TO THE BLOWER CASE.

Above all be sure to follow the instructions contained on the following pages, especially those concerning keeping the engine clean and replenishing of the oil supply.

Guarantee

The "Fullpower" Engine is guaranteed for one year against defects in material and workmanship. If within this time any part is found defective it should be returned to us, carrier charges prepaid, and if after our inspection, the part is found to be defective, no charge replacement will be made at once. Our guarantee is limited to replacement of parts and does not include any labor charges except in cases of new engines which are found not to operate satisfactorily from the start. In such cases write us, after having attempted to locate the trouble as outlined in this booklet and explain the difficulty as fully as possible. We will then advise you whether it will be necessary to return the entire engine to the factory for repairs.

Instructions For Use of Fullpower Engine Type FG

This engine has been carefully inspected and given a thorough running test before being shipped. It should, therefore, run satisfactorily now unless something has happened to it since it left the factory, provided it is properly supplied with gasoline and oil. It should be expected that it may still be

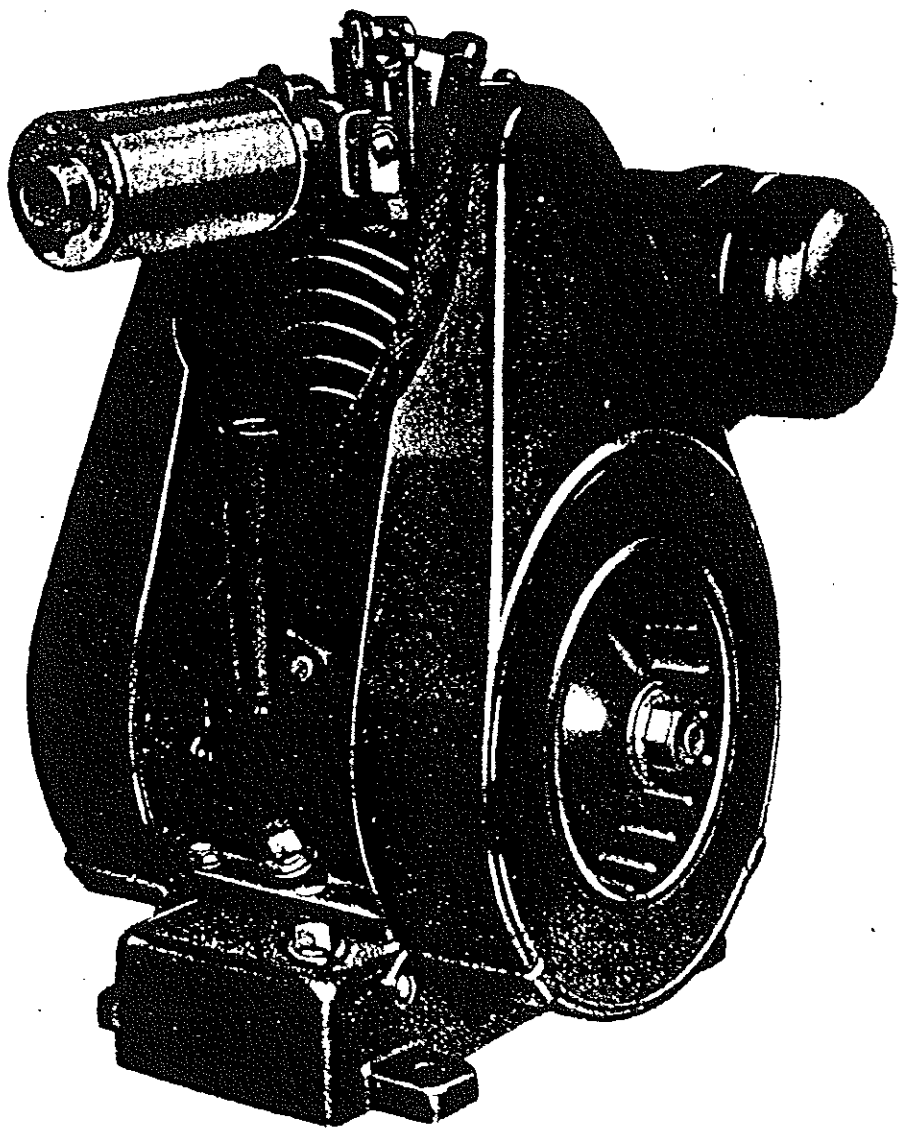

Figure 1—Model "FG" Engine

slightly stiff the first few hours' running and the operation may be expected to improve after a few hours' use. It would undoubtedly be a good idea to allow the engine to run without a load or with a light load for an hour or two before the full load is applied.

This little engine, although very simple and requiring very little care, nevertheless requires some attention and will give much better satisfaction if the instructions in this book are followed.

It is necessary to keep this engine as clean as possible. Wipe off any dirt or oil that accumulates on the engine and keep the engine covered when not in use.

Proper care in keeping the engine clean and following the instructions on the following pages will do much toward keeping down repair bills. We will try on the following pages to give sufficient information so that you should be able to take care of any simple troubles which may arise.

The Fullpower Engine operates on what is known as the four cycle or four-stroke principle, the same as practically all automobile and stationary engines. The four cycles can be explained as follows: It requires four strokes of the piston to produce one power stroke.

First Cycle or Suction Stroke: The piston moves down in the cylinder when exhaust valve is closed. The suction thus produced opens the intake valve and a charge of gasoline mixed with a proper proportion of air is drawn into the cylinder. This mixture quickly forms a gas when the engine is hot. When the piston reaches the bottom of the cylinder and there is no more suction the spring on the intake valve closes it.

Second Cycle or Compression Stroke: The piston now makes the up or compression stroke. Both valves being closed, you will readily see that the charge of gas must be compressed into the small space in upper end of cylinder when the piston reaches the upper end of its stroke.

Third Cycle or Power Stroke: An instant before the piston reaches the end of its second stroke the timer breaks a contact in the ignition circuit, and this causes a spark to leap across the points of the spark plug. This ignites the compressed gas, which

in burning expands so rapidly as to cause the term "explosion" to be used when describing this operation. It takes an instant for all the gas to ignite, and the spark is so timed that by the time all the gas is burning the piston has passed the upper end of the stroke and started down again. The rapid expansion of the burning gas pushes the piston down, forming the power stroke.

Fourth Cycle or Exhaust Stroke: When the piston reaches the bottom of the power stroke the exhaust valve is opened by the push rod and the piston in moving up forces all the burnt gases out of the cylinder. At the top of the exhaust stroke the exhaust valve closes and the first cycle or suction stroke takes place again, followed by the other strokes as described.

All the cycles or strokes take place more rapidly than they can be described, but we believe that this explanation of the operation of the engine will help you understand it better and thus enable you to keep it in perfect running order.

Inspection

Examine spark plug to see that it is screwed in place and is not cracked or broken. See that ignition cable terminal is securely fastened to spark plug.

Depress intake valve several times. It should snap up freely when released.

Revolve flywheel several times and watch exhaust valve stem, rocker arm and pushrod. These should work freely once every second revolution of flywheel. When exhaust valve is seated, or up, there should be a space between the exhaust valve stem and rocker arm of about double the thickness of a piece of newspaper.

If the space between the exhaust valve stem and rocker arm is not as outlined above, the adjustment is made on the rocker arm fork or "yoke". Revolve flywheel until valve push rod and end of rocker arm are in lowest position. Loosen set screw holding rocker arm fork in place, raise rocker arm and fork and insert two thicknesses of newspaper between the valve stem and rocker arm. Lower rocker arm and fork gently until

one end of rocker arm rests on paper on valve stem and other end of rocker arm is seated on valve push rod. Then securely tighten set screw holding rocker arm fork in place and your valve adjustment is properly made.

If rocker arm is removed entirely, care should be taken so that the small slug No. 65232, which is placed between the set screw and rocker arm fork, does not drop out. The purpose of this slug is to prevent the set screw from marring the rocker arm fork when same is drawn up tight.

Filling

Gasoline tank is filled through openings in top. Examine filler plug to see that small vent hole is clear and fill tank with a good grade of high test gasoline. Replace plug.

The oil filler opening is on either side of the engine, one side opposite the carburetor, the other below the breather pipe. With the engine setting level pour oil in this opening until it overflows. This is the maximum oil level. Replace filler plug. We recommend the use of Mobiloil A, which we have found to be of the proper characteristics for all conditions except outdoor use in winter weather when we recommend "Gargoyle Mobiloil Artic." Oils may be obtained everywhere.

Lubricating System

Lubrication of the Type FG Fullpower Engine is accomplished by the well known splash system. A positive action pump actuated by the cam shaft pumps the oil from the bottom of the oil pan into a dip trough, maintaining a constant level of oil in this trough, irrespective of the amount of oil supply in pan. Into this trough, the dipper on the lower end of the connecting rod dips on each stroke of the piston, distributing the oil in the form of a fine spray throughout the cylinder walls and crank case. By this means all moving parts are kept lubricated at all times.

IMPORTANT. Each day, before engine is started, a few drops of oil should be placed on the exhaust valve stem and rocker arm pin. This is very essential as same will prevent the exhaust valve from wearing into the cylinder head.

After filling the oil reservoir through the oil filler opening as directed under paragraph headed "Oiling" no further attention is necessary except to examine the oil level as indicated by the height of the oil in the filler opening every five running hours. The first few times running a new engine it is advisable to check the oil level every two hours. The oil reservoir should be as nearly full as possible at all times.

Draining Crankcase Oil

To reduce wear and maintain the efficiency of the engine, the lubricant must be kept in serviceable condition. This can only be done by draining the crankcase at regular intervals and filling with fresh oil.

ONCE EVERY FIFTY RUNNING HOURS DRAIN THE OLD OIL OUT OF THE ENGINE BY TIPPING IT AND POURING THE OIL OUT OF THE OIL FILLER OPENING. THE OIL SHOULD THEN BE REPLACED BY FRESH OIL. THIS SHOULD BE DONE WHILE THE ENGINE IS STILL HOT, AS WHEN THE ENGINE IS COLD IT IS IMPOSSIBLE TO GET ALL THE OLD OIL OUT.

Oil does not break down or undergo any permanent thinning when it is heated. When diluted with a certain amount of fuel, however, its body may be reduced so that it will not properly separate the friction surfaces. Dilution is especially troublesome in cold weather.

The crankcase oil also becomes contaminated with dust, drawn through the air intake of the carburetor into the combustion chamber, which works past the rings, and by dust entering through the crankcase breather. Particles of worn metal or carbon which flakes off the underside of the piston heads also contribute to this contamination. The accumulation of worn metal particles is greatest in a new engine, while the friction surfaces are being "worn-in" to a permanent finish.

Therefore, to prolong the life of the engine, the crankcase should be drained of used oil after every 50 hours of operation, and refilled with fresh oil of the recommended grade. In case the engine is not setting level, the lower of the two drain plugs, shown in Figure 1, should be used.

Drain the reservoir after a run when the engine is hot. The oil is then more fluid and thoroughly mixed and will carry off sediment more readily.

Do not flush with kerosene because quantities of it will be trapped in the engine and will remain to dilute the fresh oil.

STARTING

First make sure that the oil level is correct as described above and also make sure that the gasoline tank is supplied with plenty of gasoline. Depress intake valve once or twice. (This need only be done on a cold engine.)

Slip the knot of the starter rope into the "V" of the starter pulley and wind all the cord on the pulley snugly, winding in a clockwise direction when facing the engine from the starter pulley side. Grasp the cord and give it a **fast hard pull** so as to **spin** the engine. The cord will become disengaged from the pulley at the end of the pull. If the engine is cold it may be necessary to repeat this operation two or three times.

As soon as the engine starts to turn over, open choke valve in air cleaner. If engine is cold it may slow down or sputter immediately after starting. In this case choke the carburetor again for a few seconds.

If Engine Fails To Start Properly

If the engine fails to start properly the following suggestions may be of value and should be followed one by one until trouble is found:

CAUSES

1. Intake valve may be stuck.
2. No gasoline in tank.
3. Water in gasoline.
4. No spark or poor spark.
5. Governor arm improperly adjusted.
6. Carburetor gas line plugged up.

REMEDIES

1. Depress valve several times, making sure same works

freely. (Always do this when starting a cold engine.)

2. Fill tank with gasoline.
3. Drain tank and refill.
4. Inspect and test spark plug and if not in good condition replace plug. Be sure cable is tight and breaker points are properly set. Refer to paragraph headed "Ignition" for detail ignition tests.
5. Loosen set screw, move governor arm to the right and tighten in place. See paragraph headed "Speed Regulation."

Troubles and Remedies

ENGINE LACKS POWER OR DOES NOT OPERATE SMOOTHLY

1. Leaky valves and engine badly carboned.
2. Compression leaks at other points.
3. Weak valve springs.
4. Clearance too great between exhaust valve and rocker arm.
5. Muffler clogged.
6. Dirty or cracked spark plug.
7. Engine overheating.
8. Worn piston rings.
9. Equipment operated by engine may be binding or otherwise working improperly.
10. Carburetor clogged up.

REMEDIES

1. Head should be removed (see paragraph on "Lack of Compression"). Carbon should be thoroughly cleaned out and exhaust valve ground to a seat.

2. Spark plug must be securely screwed into head. Be sure gasket is in place. Cylinder head gasket may leak. Test for air leak and replace if necessary. Use only copper and asbestos gasket as supplied with engine.

3. Weak valve springs may be tested by inserting the point of a screwdriver into the coils and placing tension on the spring. If engine speeds up to normal, spring should be replaced. Head should be removed and valves removed as described in para-

graph headed "Lack of Compression". Only valve springs as supplied by the factory for this purpose are to be used. The exhaust valve spring must be considerably stronger than the intake valve spring.

4. See third paragraph under "Inspection."

5. Make sure that small holes in muffler are not clogged.

6. Clean spark plug thoroughly and set points at .020" clearance. Replace plug if defective in any way. See paragraph headed "Ignition".

7. Caused by poor grade of oil or lack of oil or overload or tight bearings.

8. This condition will not occur until engine has had a great deal of use or has been run with poor or an insufficient quantity of oil. Replacement should be made by a reliable repair man or by the factory.

9. Disconnect engine and test equipment for freedom of movement or amount of friction. Be sure the equipment is kept well oiled and greased.

10. Same as No. 6 under "Engine fails to start properly."

Engine Knocks

1. Engine badly carboned.
2. Loose connecting rod.
3. Loose crankshaft bearing.
4. Loose flywheel.
5. Lack of oil.

REMEDIES

1. Proceed to clean out. See paragraph "Lack of Compression".

2. and 3. Have repairs effected by a reliable repair man or return to factory. This condition is caused only by poor oiling or long service.

4. Be sure flywheel nuts and pulleys are properly tightened. Replace key on crankshaft if necessary.

5. Replenish oil supply.

Carburetor

This carburetor is provided with one adjustment and that controls the volume of fuel delivered through the main nozzle. Turning to the right, or clockwise, closes off the amount of fuel fed through the main nozzle. Turning to the left, or counter clockwise, increases the amount of fuel fed through the nozzle.

Carburetors on the Briggs & Stratton, Model FG engine, are adjusted at the factory at three-fourths of one turn open. To find the point at which the motor delivers maximum power, first start the engine and run until thoroughly warm. With the engine properly warmed, turn to the right very gradually until motor indicates loss of power from lack of sufficient fuel. When this position is found, turn gradually to the left until that position of the adjustment gives maximum power.

We advise when starting cold motor to set adjustment at from three-fourths to one full turn open.

If necessary to clean gas line, in doing this no difficulty will result if this procedure is followed: Close shut off valve connecting gas tank with gas line. Unloosen nuts holding gas line, detach, clean and replace by turning nuts until tight. Open shut off valve.

For use outdoors or where there is much dirt or dust we have developed an air cleaner which slips into the carburetor air opening. The air cleaner proper can be removed from the tube by merely pulling same off. EVERY DAY the air cleaner should be rinsed or cleaned in kerosene to remove all dirt which may accumulate. Then dip in old crank case oil and replace.

Ignition

If the engine fails to start, remove ignition cable from spark plug and remove spark plug. See that points are clean and about .020" apart. This will be a trifle greater than 1/64". Attach ignition cable firmly to spark plug and lay spark plug on top of engine so that steel part of plug is touching engine. Grasp ignition cable by the insulation and keep plug in place as above. Revolve flywheel smartly by hand several times. At a point dur-

ing each revolution a spark should jump across the gap in the spark plug providing spark plug is laid so that steel part is touching engine. If there is no spark the probabilities are that the spark plug is cracked or porous. Replace with a plug of reputable manufacture that you know has been tested and is O. K.

CAUTION: Never in any case try to test for spark by removing ignition cable from spark plug, trying to hold terminal of cable close to cylinder, revolving flywheel and watching for spark between ignition cable terminal and cylinder. You run an excellent chance of completely ruining your magneto if you test in this manner.

If there is still no spark remove pulley from end of crankshaft that holds magneto flywheel in place. Pulling outward on the flywheel, tap the end of the crankshaft gently with a piece of wood, brass or lead. Do not strike end of crankshaft with hammer or other hard substance as you will ruin the thread. This gentle tapping will loosen flywheel from its taper seat and it will come off of the crankshaft. Place keeper across magnets of flywheel to prevent demagnetizing. Any flat piece of steel will serve for this purpose. You will then have exposed to view the breaker arm 65489. You will note that the breaker arm is pivoted in the center, with one end riding on the crankshaft. On the other end is located a tungsten point with another located opposite it. You may find that there is oil or foreign substance between these points or they may be burned. (Note: The latter only after an engine has seen considerable service.) If found to be dirty, clean well with a piece of fine sand paper. If the points are rough scrape them with a sharp knife, but under no condition use emery cloth. When the points are separated the greatest, the gap should be about .020 of an inch.

Another important matter to watch is the proper fastening of the magneto cable which reaches from the connection on the coil to the spark plug. This cable should be securely fastened at both the coil and the spark plug. Fasten the cable to the coil connection with a pair of pliers. Under no circumstances is the cable to be soldered to the coil. This heat will damage the

winding. To insure the cable not coming loose at the coil, secure with the clamp just to the left of the points. This will insure a good connection even though the cable is jerked. The insulation of the coil and cable must not be cracked or oil soaked. Replace flywheel carefully and try as before. If still no spark develops there is something wrong that you cannot remedy and the engine should be returned to the factory or to a competent ignition expert for further repairs.

When replacing flywheel be sure that the taper end of the crankshaft and the taper hole in flywheel are absolutely clean to insure proper fit of flywheel to the shaft. Insert a bar or rod through the two holes in the starter pulley (which acts as a nut to hold the flywheel in place) and tighten securely by hitting bar with hammer. **PULLEY MUST BE DRAWN UP TIGHT.**

The key, which holds the flywheel in place, is made of aluminum so that it will shear off if the pulley becomes loose, thereby not allowing any damage to be done to the keyways in the flywheel or crankshaft.

Lack of Compression

The mixture of gasoline from the carburetor must be compressed on the up stroke of the piston and in this condition fired by the spark jumping across the gap in the spark plug. If this compression is faulty there will be either no explosion or insufficient explosion to develop full power by the engine. To determine if you have compression revolve flywheel at a moderate speed by hand. If compression is correct, there will be a point during every second revolution where resistance will be felt. It will feel as if pull were against a spring and if the flywheel is revolved, fairly fast, up to this point of resistance and let go, it will rebound rapidly in the opposite direction. If this action does not take place there is no compression and the cause must be looked for. There are four causes of poor compression which you can easily determine and remedy.

1. Cylinder head loose. Can be detected by air coming through between cylinder and cylinder head and by oil oozing

out at same place. Turn screws down tightly and if this does not remedy condition, use a new copper and asbestos gasket.

2. Spark plug loose. Screw down and if necessary replace gasket.

3. Exhaust valve not seating properly. First examine the exhaust valve spring and make sure it is not broken. If not broken insert the point of a screwdriver between the coils and place tension on the spring. If this makes the engine run normally the spring is weak and should be replaced. If spring is not at fault the valve may be badly carboned and need regrinding. (The latter can only occur in engines which have been running for some time and will never happen on new engines). To replace spring or regrind valves see paragraph on "Cylinder Head and Valves" for method of removal from engine.

4. Intake valve not seating properly. Depress the valve by hand several times. It should snap up freely. Test the spring as outlined above for exhaust valve spring. It should very seldom be necessary to replace intake valves. See paragraph "Cylinder Head and Valves".

If none of the causes mentioned above seem to be responsible for the lack of compression see paragraph headed "Worn Rings and Scored Cylinders" for further suggestions.

Cylinder Head and Valves

Adherence to the following will be of assistance in removing cylinder head.

Remove ignition cable from spark plug, loosen nuts on blower case housing bracket, also screws holding bracket to cylinder head. This will permit of turning bracket so that it is under housing and obviate the necessity of the removal of the blower case assembly. Close gasoline shut off valve—loosen gas line nuts and remove line. Remove carburetor. Loosen nuts on gas tank (upper half of brackets only), which will permit of access to the gas pipe which may then be removed. It is then only necessary to remove the remaining two screws. The cylinder head may now be lifted.

It is recommended that the 65509 cylinder head gasket be replaced each time the cylinder head is removed.

To regrind the exhaust valve it should not be necessary to remove the valve from the cylinder, unless the valve is in very bad condition. It should very seldom be necessary to regrind the intake valve. Secure a small amount of valve grinding compound from any garage, auto supply or motorcycle supply store and cover the seat of the exhaust valve thinly with this compound, oscillating the valve rapidly in the seat. When clean metal shows all around on both the valve and seat, and there are no pits or black spots showing, the valve is properly ground. Wash valve and seat thoroughly with gasoline before assembling.

When necessary to remove exhaust valve to regrind or to replace exhaust valve spring, the following suggestions will be found helpful. The head should be laid on a bench with some means of supporting the exhaust valve from beneath, as a block of wood, etc. Using a tube, pipe or anything else that will bear down on the collar at the upper end of the exhaust valve stem without touching the split sleeve next to the stem, drive the collar or sleeve retainer down by several taps with a hammer. The split sleeve will then drop out, enabling the valve parts to be disassembled. If no other tool is available, the flywheel nut may be used to drive down the sleeve retainer or collar as described above. Always grind in, as described above, a new valve before assembling.

After assembling adjust the rocker arm. There should be a space about double the thickness of a piece of newspaper between the exhaust valve stem and the rocker arm, when the exhaust valve is seated or up. This adjustment can be made as outlined in the first paragraph under the heading "Inspection" on page 7.

The intake valve is spun in place on the cylinder head and we do not recommend replacement except by a competent repair shop or the factory. There should be very little occasion to replace intake valves. In many cases when necessary to replace intake valves it may be advisable to replace entire cylinder

head. If necessary to replace intake valve spring, the entire cylinder head may be returned to the factory to have spring replaced and valve seats reground at a cost of \$2.00 net. This includes new valves.

All Model FG Fullpower Engines are equipped with a cylinder head gasket composed of copper and asbestos. While it is possible to use this part a second time it is advisable to use a new gasket when available. Place intake tube in head and put head in proper position on cylinder, making sure that other end of tube is properly inserted in the carburetor. Insert screws, attaching magneto cable clip and upper blower clamps and draw to seat. Tighten all screws, a half turn at a time so as to bring head down evenly on the cylinder.

Worn Piston Rings or Scored Cylinders

This condition can be identified by the sound of air rushing down into the crank case when point of compression is reached. This would only occur after long use of the engine unless the engine was run without sufficient oil, or with a poor grade or dirty oil, or continuously overloaded.

In the condition, or whenever the engine does not perform satisfactorily and you have proper gasoline, ignition and compression at other points, we recommend that either a competent gas engine expert repair the engine, or it be returned to the factory for repairs.

If the engine is torn down, in no event use any gasket, except the copper and asbestos cylinder head gasket, a second time. Always use new gaskets.

Speed Regulation

The speed of the engine is set properly when leaving the factory, and there should be no need of adjustment unless the governing mechanism has been disarranged in transit. If it is necessary to change speed, proceed as follows.

Immediately in rear of carburetor will be found a arm lever attached to a small stem entering carburetor. From one of the

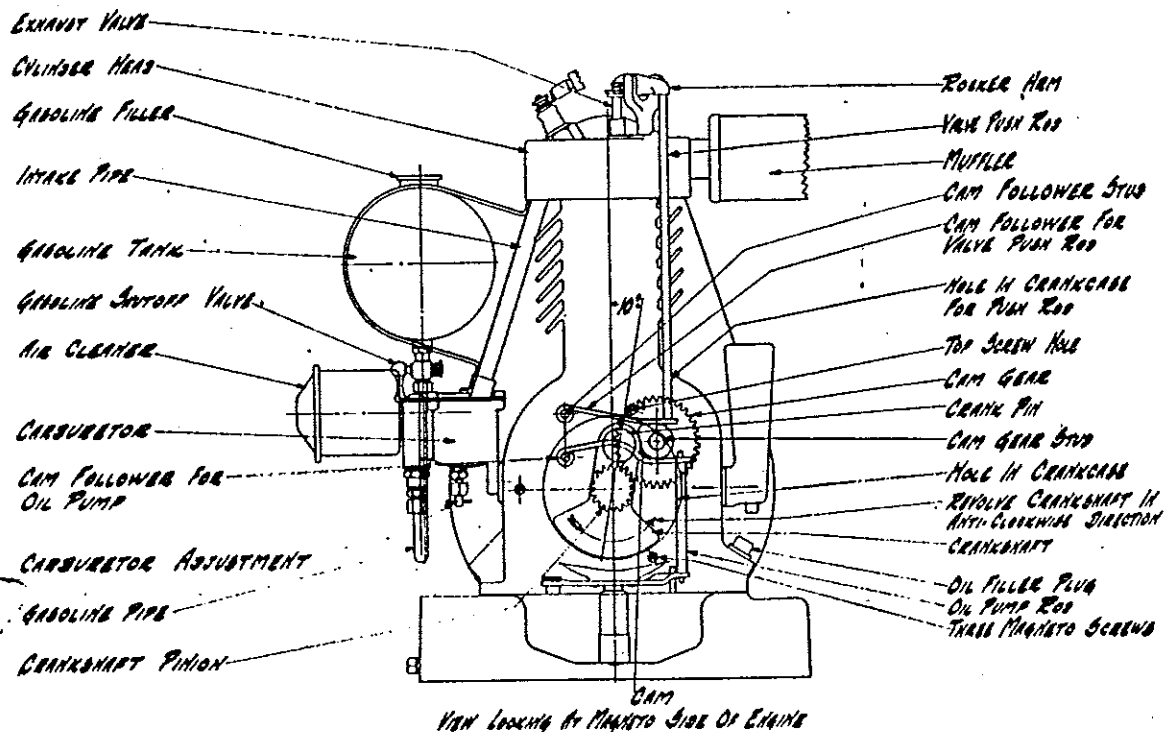

FIGURE 2—Timing Diagram

holes in this arm a wire extends to the governor in the flywheel. From the other hole a coil spring extends to a small bracket fastened to the blowercase by a screw. Loosen this screw and move bracket down to decrease speed, and up to increase the speed.

If the connecting rod has not been disassembled from the crank shaft, even though the engine has been otherwise disassembled, the timing gears will not be disengaged and the engine will not have to be retimed.

When taking the engine apart closely observe the relative position of the cam followers and other parts and how they are removed as this will be of great aid when reassembling.

Timing

If the connecting rod has been disassembled from the crank shaft, the timing gears will have been disengaged, and when reassembling the engine the gears must be properly engaged, or the engine will not run. Referring to diagram, figure 2, will make timing instructions outlined in the following paragraphs, clearer.

After the connecting rod has been properly assembled to the piston by means of the piston pin, this pin being locked by the piston pin lock, the piston and connecting rod is inserted into the cylinder from the top, the cylinder head being removed. Insert the crank shaft through the large opening in the crank case, from which the magneto was removed, meshing the pinion (small gear) on the crank shaft with the cam gear. This cam gear should be on its stud with the cam part of the gear toward the wall of the crank case. The cam followers should be on their studs, secured in place by cotter pins, with the free ends of the cam followers riding on the cam of the cam gear.

The cam follower for the valve push rod, or the shorter one of the two, is mounted on the upper stud. Care should be taken to mount same correctly. The free end should point upwards and rest on the upper side of the cam. The cam follower for the oil pump, or the long bent one, should be mounted on the lower stud and rest on the lower side of the cam.

Insert valve push rod through small hole in top of crank case, lower end of rod resting on cam follower. Revolve crank shaft to the left or anti-clockwise, at the same time holding push rod down on cam follower until the push rod just begins to rise. It will be best to do this several times so the exact spot may be determined. You will readily feel when the cam begins to push the cam follower and push rod up. If you have the timing gears properly meshed, the crank pin of the crank shaft, or, in other words, the part of the crank shaft to which the connecting rod will be fastened, will be nearly in its topmost position. It will be to the right of its topmost position about 10° and will be pointing, nearly directly, towards the top one of the three screw

holes in the crank case, in which the screws fit that fasten the magneto to the crank case.

If, when the push rod is just beginning to rise, the crank shaft is not in the correct position, pull it straight out toward you, disengaging the timing gears. Revolve it until it assumes the correct position described above, then push it straight in, engaging the timing gears. During this operation be sure that the cam gear has not moved. If you should engage the gears incorrectly, even so little as one tooth, the position of the crank shaft, when the push rod begins to rise, will be so far wrong that it will be readily apparent.

After the gears have been meshed properly, assemble the connecting rod to the crank shaft, being sure that the screws holding the connecting rod cap in place are drawn down tightly and have lock-washers under each head.

Always use new gaskets when reassembling the engine.

To Stop Engine

Engine can be stopped in several ways. Intake valve can be held down, governor throttle can be moved to extreme left and when engine is equipped with a short circuiting switch the switch should be closed and held closed until the engine stops. Be sure short circuiting switch is open when attempting to start engine. It is very poor practice to stop the engine by choking the carburetor as this practice has a tendency to flood the engine with raw gasoline which washes the oil out of the pistons and rings tending to make hard starting.

Operation and Care

Always use a good grade of high test gasoline and be sure there is a sufficient amount in the tank. Use the very best grade of cylinder oil of medium weight. Be sure oil is up to proper level.

Inspect spark plug frequently and keep points free from carbon and at proper distance from each other.

KEEP YOUR ENGINE CLEAN. THIS PROLONGS LIFE OF ENGINE AND INSURES SATISFACTORY OPERATION AT ALL TIMES.

Repairs

We have attempted to describe in this booklet only those repair operations which might well be undertaken by the average man with slight mechanical skill. If it is necessary to undertake any serious repairs to the magneto, replace piston, piston rings, bearings, or regrind cylinders, we recommend that the engine either be sent to a competent repair shop or to our factory for repairs. This should not be necessary until the engine has seen considerable service.

Ordering Parts

We are listing below a list of parts of the Type FG Full-power Engine for your convenience in ordering parts.

In order to avoid delay and unnecessary correspondence, the INSTRUCTIONS BELOW MUST BE CAREFULLY OBSERVED IN ORDERING PARTS. Do not order parts in the same letter you write on any other subject. Be sure to write plainly and legibly.

Description of Parts

Select the part numbers by referring to both the list of parts and the illustrations of parts. Always refer to both the description and the illustration to make sure the proper part number is selected. If unable to determine the proper number of the part wanted describe it as fully as possible. Do not depend on the numbers cast on parts as being correct as they may only cover part of what you want if it is an assembly.

ALWAYS USE BOTH PART NUMBER AND DESCRIPTION OF PARTS ORDERED, IF POSSIBLE. ALWAYS GIVE THE NUMBER OF THE ENGINE ON YOUR ORDER. **Service orders cannot be filled unless these numbers are given.** This number will be found on the name plate riveted to the Blower

Case and is preceded by the type letter which should always be shown on the order.

Shipping Instructions

Always specify on the order whether shipment is desired by parcel post, express or freight. In absence of any instructions we will always ship the cheapest way.

Remittance

REMITTANCE SHOULD ACCOMPANY EACH ORDER. We will not ship any parts C. O. D. unless a deposit of more than twice the transportation charge has been made. Remittance must include sufficient to cover postage charge if to be shipped by mail as well as ten cents (\$0.10) to cover insurance. Any excess remittance will be refunded. **MINIMUM CHARGE FOR PARTS IS 25 CENTS PLUS POSTAGE AND INSURANCE.**

Remit either postoffice or express money order. Postage stamps will be accepted in amounts of less than one dollar (\$1.00) only.

Prices

All prices in this book are subject to change without notice. In case of changes in price, orders will be filled at current prices. All prices shown are F. O. B. our factory in Milwaukee, Wis.

Instructions on Return Material

Never return material to us without writing us a letter explaining what parts are being returned, the **engine number** and the reason for return. Mark the shipment both outside and by tag on the parts with your name and address. Do not include any instructions in package, however. All instructions must be sent by mail to secure prompt attention. No return shipments will be accepted unless return transportation charges are prepaid.

Never return any material to the factory without first receiving permission from us to do so, except incorrect shipment of parts, defective material returned for replacement or material returned for repairs at your expense.

Parts Price List for "FG" Fullpower Engine

Part No.	Description	Price
EAAB	Cylinder Head Assembly—Consisting of EA2 Cylinder Head—EA15 Intake Valve, EA46 Intake Valve Spring, EA86 Intake Valve Collar, EA45 Exhaust Valve Spring, EA57 Valve Spring Gasket, 65562 Valve Spring Washer, 65893 Exhaust Valve, 65903 Exhaust Valve Sleeve, 65913 Exhaust Valve Sleeve Retainer	\$10.00
EA0	Muffler	2.50
EA12	Cam Gear	2.00
EA23	Cam Follower (Valve Push Rod)45
EA30	Throttle Spring Clip10
EA45	Exhaust Valve Spring15
EA56	Diaphragm Gasket04
EA57	Valve Spring Gasket05
EA79	Push Rod10
EA84	Drive Pulley (Furnished only when specified)	1.60
EA97	Drain Plug 1/8"06
EA100	Cylinder Screw05
EA101	Carburetor Screw03
13AJ	Pump Plunger30
13A2	Connecting Rod Lockwasher01
13A10	Crank Case Cover Gasket12
13A11	Governor Flywheel Nut 9/16", No. 18 Thread21
13A27	Connecting Rod Screw05
13A34	Connecting Rod Shim10
13A40	Pump Spring07
7BC	Spark Plug with 7B24 Gasket	1.00
7B24	Spark Plug Gasket03
7B30	Breather Tube Gasket10
7B33	Breather Tube & Gas Tank Lockwasher01
7B35	Governor Screw01
13B30	Governor Flywheel Lockwasher03
7F12	Gas Tank Nut05
7F22	Carburetor & Cylinder Lockwasher01

Part No.	Description	Price
7J94	Cam Follower Cotter Pin01
13MB	Armature	9.80
13ME	Contact Bracket with Point52
13MF	Ignition Cable50
13MG	Condenser	2.50
13M2	Armature Screw05
13M12	Bracket Bushing06
13M13	Breaker Arm Spring05
13M17	Bracket Washer05
13M21	Bracket Shim05
13M22	Ignition Cable Clamp07
13M33	Coil Insulator10
13M36	Contact Bracket Screw02
13M47	Condenser Screw03
13M50	Armature Lead Insulator 3" Long05
7TC	Gasoline Shut-off Valve70
7T17	Air Guide & Throttle Spring Lockwasher01
7W8	Air Guide Screw03
65107	Ignition Cable Sleeve10
65126	Throttle Spring15
65167	Condenser Lead Insulator05
65229	Rocker Arm Assembly consisting of 65861 Rocker Arm, 65281 Rocker Arm Fork, 65303 Rocker Arm Pin	2.50
65232	Rocker Arm Set Screw02
65236	Piston Pin Lock05
65281	Rocker Arm Fork	1.50
65299	Cylinder Head Assembly consisting of EAAB Cylinder Head Assembly, 65229 Rocker Arm Assembly, 65232 Slug, 90680 Set Screw	12.50
65303	Rocker Arm Pin10
65411	Oil Filler Plug $\frac{3}{8}$ "10
65419	Breather Tube	1.90
65451	Piston Ring55
65489	Breaker Arm Assembly	1.50
65499	Gas Tank Cap50
65509	Cylinder Head Gasket08
65522	Large Blower Case Clamp (Side)15
65546	Throttle Link15
65562	Valve Washer05

63871 offset cam gear steel

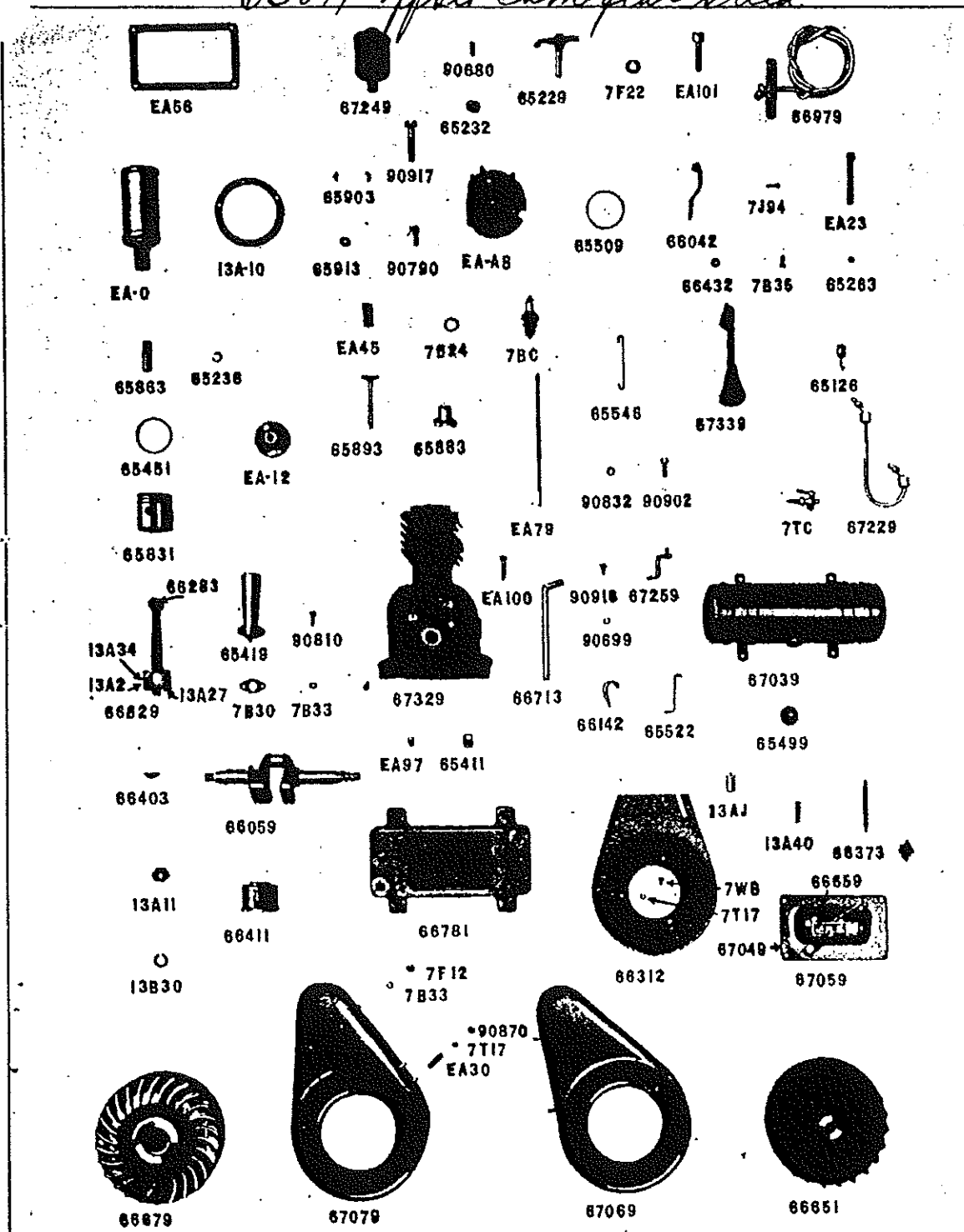
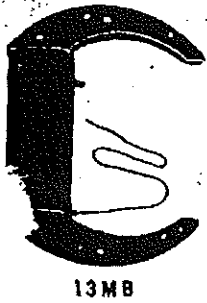

Figure 3 — Type "FG" Engine Parts

Part No.	Description	Price
65659	Magneto Assembly complete with Air Guide	22.50
65689	Crank Case Cover with Air Guide	6.00
65731	Drive Pulley (Only when specified)	1.10
65793	Bushing	1.00
65831	Piston	2.75
65861	Rocker Arm	1.00
65863	Piston Pin60
65893	Exhaust Valve (Order 65903 and 65913 to complete)	1.00
65903	Exhaust Valve Sleeve10
65913	Exhaust Valve Sleeve Retainer15
66042	Cam Follower for Oil Pump45
66059	Crankshaft	12.00
66069	Piston Assembly (65831 Piston and 2-65451 Rings)	3.85
66142	Ignition Cable Clamp05
66263	Cylinder Bushing	1.25
66283	Bushing for Connecting Rod40
66312	Air Guide20
66363	*Retainer Stud for riveting Oil Trough and Pump Assemblies10
66373	Oil Pump Rod10
66403	Woodruff Key15
66411	Starter Pulley	1.00
66432	Governor Arm Washer05
66629	Connecting Rod Assembly consisting of Connecting Rod, 13A2 Lockwasher, 13A27 Screw, 13A34 Shim, 66283 Upper Bushing	4.00
66651	Governor Flywheel	5.50
66659	*Oil Trough35
66679	Magneto Flywheel	12.25
66713	Intake Pipe75
66781	Base	6.00
66979	Rope and Grip30
67039	Gasoline Tank with Cap	5.25
67049	*Oil Pan Assembly consisting of 66262 Oil Pan, 66383 Guide Pin, 13A35 Pump Body, 13A38 Pump Ball, 13A12 Pump Screen, 66233 Ball Retainer	1.65
67059	*Oil Pump Assembly consisting of 67049 Oil Pan Assembly, 66659 Oil Trough Assembly, 66363 Retainer Stud	2.00
67069	Magneto Blower Case	1.25
67079	Governor Blower Case	1.25



13MB



13M33

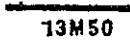

13M50

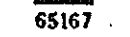

65167



66679

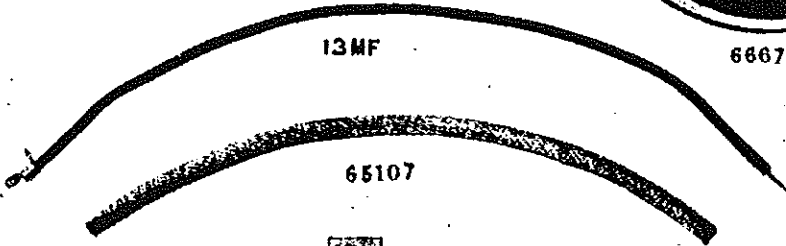

13MF

65107



13M21



13M22



7T17



65489



13M36 13M2



13M12



13M13 13ME



13M17



13M47 7W8

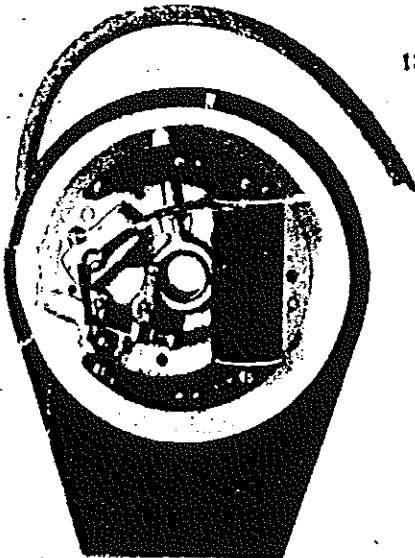

65659



13MG

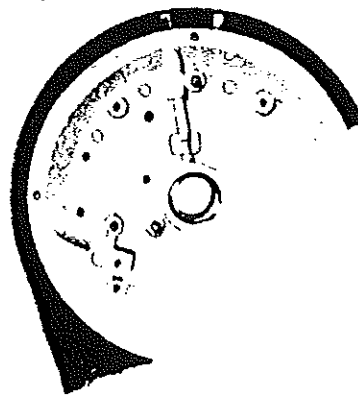

65793

Part No.	Description	Price
67219	Carburetor Assembly	7.50
67229	Gasoline Pipe75
67249	Air Cleaner	2.50
67259	Upper Bracket with Screw20
67329	Cylinder Assembly consisting of Cylinder, 65883 Bushing, EA62 Cam Follower Stud, EA63 Can. Gear Stud	17.00
67339	Governor Arm Assembly75
90680	Rocker Arm Set Screw05
90699	Blower Case Clamp Lockwasher01
90790	Cylinder Head Screw (Thick Head)05
90810	Breather Tube Machine Screw05
90832	Lockwasher (Magneto Cover Plate)01
90870	Throttle Clip Nut01
90902	Screw (Magneto Cover to Crankcase)01
90916	Side Bracket Screw05
90917	Cylinder Head Screw (Thin Head)05
90933	Mounting Bolt05

*Oil Pan Assembly 67049 and Oil Trough 66659 must be riveted together with 66363 Retainer Stud to complete 67059 Oil Pump Assembly.

67219 CARBURETOR PARTS

EA28	Throttle Shutter05
65114	Gasket05
65124	Gasket05
65134	Gasket05
65387	Stuffing Box Packing05
65397	Float Bowl Cover Gasket10
65402	Throttle Control10
66322	Air Cleaner Clip15
66773	Stuffing Box Nut25
66783	Stuffing Box Gland25
66791	Float Bowl Cover10
66793	Float Lever Pinion Screw	3.00
	Body50
	Inlet Seat25
	Connector20
	Cover Vent Screw10
	Idle Shaft15
	Idle Valve Adjusting Screw30
	Needle	1.00
	Screw	1.00
	Screw Lockwasher05
	Stop Pin05
	Screw05