

# Operating Instructions

Adjustment and Repair  
Information • Parts List

## MODELS

"N"—"NP"—"NR"

TYPE NUMBERS FROM 205000 TO 205499

**IMPORTANT**  
**ALWAYS USE**  
**GOOD, CLEAN OIL**  
**S. A. E. No. 20**

For Temperatures Below 32° F.  
Use S. A. E. No. 10W

**ADD OIL FREQUENTLY**  
**CHANGE OIL REGULARLY**

**IMPORTANT**  
**ALWAYS USE**  
**GOOD, CLEAN OIL**  
**S. A. E. No. 20**

For Temperatures Below 32° F.  
Use S. A. E. No. 10W

**ADD OIL FREQUENTLY**  
**CHANGE OIL REGULARLY**

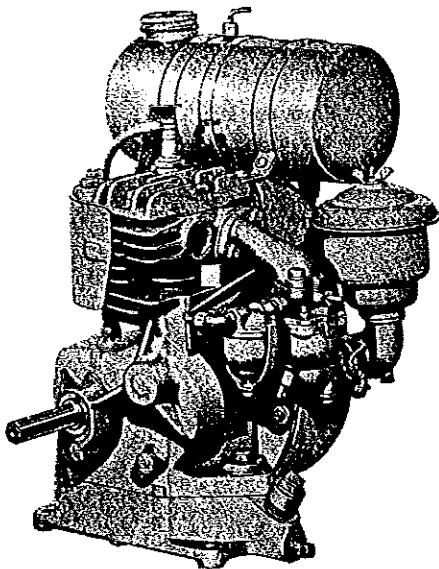

### INDEX

	Page
Starting the Motor.....	2
Servicing Reference Chart.....	3
Instructions for Adjustment and Repair.....	3
Repair Parts .....	10
Parts List, Models "N," "NP," "NR".....	11-18
Illustrated Parts .....	17-18
Guarantee .....	18
Nation-Wide Service Organization.....	19
Authorized Central Service Distributors.....	19

Read these instructions carefully before operating this Motor for the first time.

Guessing how to run it may cause you unnecessary inconvenience, aggravation or failure to receive the fine service that is built into it.

There is a right way to operate this Motor. This book tells you how.

Each Motor is carefully tested and adjusted at the factory before packing for shipment, and if correctly operated will perform beyond your expectations.



**DO NOT START THIS MOTOR UNTIL YOU HAVE READ CAREFULLY THE "STARTING AND OPERATING INSTRUCTIONS" ON PAGE 2**



# IMPORTANT SAFETY INFORMATION AND INSTRUCTIONS FOR ENGINE SELECTION ENGINE INSTALLATION ENGINE OPERATION

In the USA and Canada, our 24 hour hotline is:  
 18002333723  
 Briggs & Stratton Corporation  
 Milwaukee, Wisconsin 53201  
[www.briggsandstratton.com](http://www.briggsandstratton.com)

Keep these instructions for future reference.





**Before installing and operating this engine read and observe all warnings, cautions and instructions on both sides of this sheet, on the engine, and in the operating & maintenance instructions.**

**NOTE:** This sheet of instructions and safety information is not meant to cover all possible conditions and situations that may occur. Read entire Operating & Maintenance Instructions for this engine AND the instructions for the equipment this engine powers. Failure to follow instructions and safety information could result in serious injury or death.

The safety alert symbol () is used to identify safety information about hazards that can result in personal injury.

A signal word (DANGER, WARNING, or CAUTION) is used with the alert symbol to indicate the likelihood and the potential severity of injury. In addition, a hazard symbol may be used to represent the type of hazard.







 **DANGER** indicates a hazard which, if not avoided, will result in death or serious injury.

 **WARNING** indicates a hazard which, if not avoided, could result in death or serious injury.

 **CAUTION** indicates a hazard which, if not avoided, might result in minor or moderate injury.



**CAUTION**, when used without the alert symbol, indicates a situation that could result in damage to the engine.

**HAZARD SYMBOLS AND MEANINGS**

 Fire	 Explosion	 Moving Parts
 Toxic Fumes	 Hot Surface	 Shock
 Kickback		







(OVER)









# ENGINE SELECTION

 <b>WARNING</b>
 
<b>Failure to select the correct engine could result in fire or explosion.</b>











- Some engines are unique and designed for specific applications or types of equipment. If this engine will be used to build new equipment, contact Briggs & Stratton to ensure that the engine is appropriate for the intended use.  
**Note: For all Go-karts use only a model 136200 series engine, which offers improved safety and performance.**
- Replacement engines should be the same model as the original engine, or be the Briggs & Stratton designated replacement engine. Refer to the Operation & Maintenance Instructions for engine identification information.  
**Note: For all Go-karts use only a model 136200 series engine, which offers improved safety and performance.**
- Do not use Briggs & Stratton engines on 3-wheel All-Terrain Vehicles (ATVs), motor bikes, air craft products, or vehicles intended for use in competitive events. Briggs & Stratton does not approve of or authorize such uses.

# ENGINE INSTALLATION

- Do not attempt to install this engine if you do not have the appropriate tools and knowledge of small engine installation procedures. Use only Briggs & Stratton parts. Contact your Authorized Service Dealer for assistance.
- Do not modify the engine in any way without Briggs & Stratton factory approval. Any such modification is at the owner's sole risk.
- If the exhaust system on the old engine was supplied by the equipment manufacturer, you must transfer the exhaust system and related components (original muffler and related pipes, brackets, clamps, and shields) to the new engine. All components must be in good condition.
- |                                                                                                    |                                                                                                                                                                                     |
|----------------------------------------------------------------------------------------------------|-------------------------------------------------------------------------------------------------------------------------------------------------------------------------------------|
|  <b>WARNING</b> | Install muffler (and muffler deflector if used) so outlet points away from operator, fuel tank, and equipment, and so muffler heat will not damage or deform engine and components. |
|                 |                                                                                                                                                                                     |
- |                                                                                                    |                                                                                                                                      |
|----------------------------------------------------------------------------------------------------|--------------------------------------------------------------------------------------------------------------------------------------|
|  <b>WARNING</b> | Ensure all fuel lines and fittings are properly assembled and do not leak. Replacement parts must be the same model as the original. |
|                 |                                                                                                                                      |
- |                                                                                                    |                                                                                                                                |
|----------------------------------------------------------------------------------------------------|--------------------------------------------------------------------------------------------------------------------------------|
|  <b>WARNING</b> | Ensure all wiring, including safety switches and engine shut-off components are completely installed and functioning properly. |
|                 |                                                                                                                                |
- Set engine speed to equipment manufacturer's specification. Refer to equipment manufacturer's manual. Do not tamper with governor springs, or other parts that will increase engine speed above specification.

- |                                                                                                  |                                                                                                                                                                                                                |
|--------------------------------------------------------------------------------------------------|----------------------------------------------------------------------------------------------------------------------------------------------------------------------------------------------------------------|
|  <b>WARNING</b> | All engine parts, including fuel cap, spark plug, muffler, air cleaner, and covers and guards for drive components (gears, belts, shafts, couplings, etc.) must be in place before attempting to start engine. |
|                |                                                                                                                                                                                                                |
- |                                                                                                  |                                                                                                                                                                 |
|--------------------------------------------------------------------------------------------------|-----------------------------------------------------------------------------------------------------------------------------------------------------------------|
|  <b>WARNING</b> | If engine is installed on walk behind lawn mower, all mower components, including cutting blade, must be correctly installed before attempting to start engine. |
|                |                                                                                                                                                                 |
- |                                                                                                  |                                                                                                                                         |
|--------------------------------------------------------------------------------------------------|-----------------------------------------------------------------------------------------------------------------------------------------|
|  <b>WARNING</b> | When working on the engine or equipment, remove spark plug wire from spark plug. For electric start, remove negative wire from battery. |
|                |                                                                                                                                         |
- |                                                                                                  |                                                                                            |
|--------------------------------------------------------------------------------------------------|--------------------------------------------------------------------------------------------|
|  <b>WARNING</b> | Do not check for spark with spark plug removed. Use Briggs & Stratton spark tester #19368. |
|                |                                                                                            |

# ENGINE OPERATION

 	 <b>WARNING</b>
	<b>When adding fuel:</b>
Turn engine off and let engine cool at least 2 minutes before removing gas cap. Fill fuel tank outdoors or in well-ventilated area. Fill tank to about 1 inch below lowest portion of neck to allow for fuel expansion. Keep gasoline away from sparks, open flames, pilot lights, heat, and other ignition sources.	
  	 <b>WARNING</b>
	<b>When starting engine:</b>
Remove all external equipment/engine loads. Wait until spilled fuel is evaporated. Start engine outdoors. Pull cord slowly until resistance is felt, then pull rapidly. If engine floods, set choke to OPEN/RUN, place throttle in FAST and crank until engine starts.	
 	 <b>WARNING</b>
	<b>When operating equipment:</b>
Do not tip engine or equipment at angle which causes gasoline to spill. Run engine outdoors. Do not run in enclosed area, even if doors or windows are open. Do not choke carburetor to stop engine.	

# Starting and Operating Instructions

	Paragraph
Before Starting the Motor.....	1
How to Start.....	2
Failure of Motor to Start.....	3

	Paragraph
How to Stop.....	4
General Data .....	5

**1. BEFORE STARTING THE MOTOR.** Fill the crankcase with Mobiloil "Arctic" or any other high grade oil not heavier than **S. A. E. No. 20** for operating motor in temperatures of 32° F. and above. For temperatures below 32° F. use Mobiloil No. 10 W or other high grade oil not heavier than **S. A. E. No. 10 W.**

**A HEAVIER OIL MUST NOT BE USED.** The oil filler plug is painted blue and is located on top of motor base. With the motor level remove filler plug and pour oil in opening until it rises to the level of the filler plug opening. Crankcase holds 1 pint. Fill air cleaner with oil of the same viscosity as used in the crankcase to the indicated oil level. See paragraph 57. Fill the gas tank with a good grade of clean, fresh gasoline. Tank holds two quarts. Do not mix oil and gasoline. See paragraphs 11 to 19.

**2. HOW TO START.** Open gas shut-off valve on top of gasoline tank, turn valve to left. Completely close carburetor choke by turning lever in a clockwise direction.

**(A) ROPE STARTER.** Wind the starting rope clockwise around the starter pulley, with knot in the pulley notch. Pull the rope with a quick steady pull to spin the magneto flywheel and prime the motor. After motor has been primed, open choke about half-

way to start. As motor warms up, gradually open choke valve until motor operates smoothly with the choke wide open. Operate the choke the same as you would on an automobile. (A warm motor does not require as much choking as a cold motor.) See paragraph 21.

**(B) FOOT OR HAND LEVER STARTER.** Step down on pedal or pull hand lever quickly with choke closed to prime the motor. Then operate choke as in paragraph 2A.

**3. FAILURE OF MOTOR TO START. COLD WEATHER** causes the oil in crankcase to become thick and the gasoline less volatile. Should you experience trouble in starting, we suggest that you give your motor a little extra priming. Also be sure that the spark plug points are clean and the gap set at .025". See plate No. 5. If motor fails to start after a reasonable number of trials do not make any adjustments until you have studied the instructions referred to in the **Servicing Reference Chart**, on page 3.

**4. HOW TO STOP.** Press the stop switch mounted on the cylinder head against the end of the spark plug. Hold it until motor stops firing. This will ground the spark. To stop models equipped with ignition shielding, push the red stop pin, located on the blower case below gasoline tank.

Plate No. 1

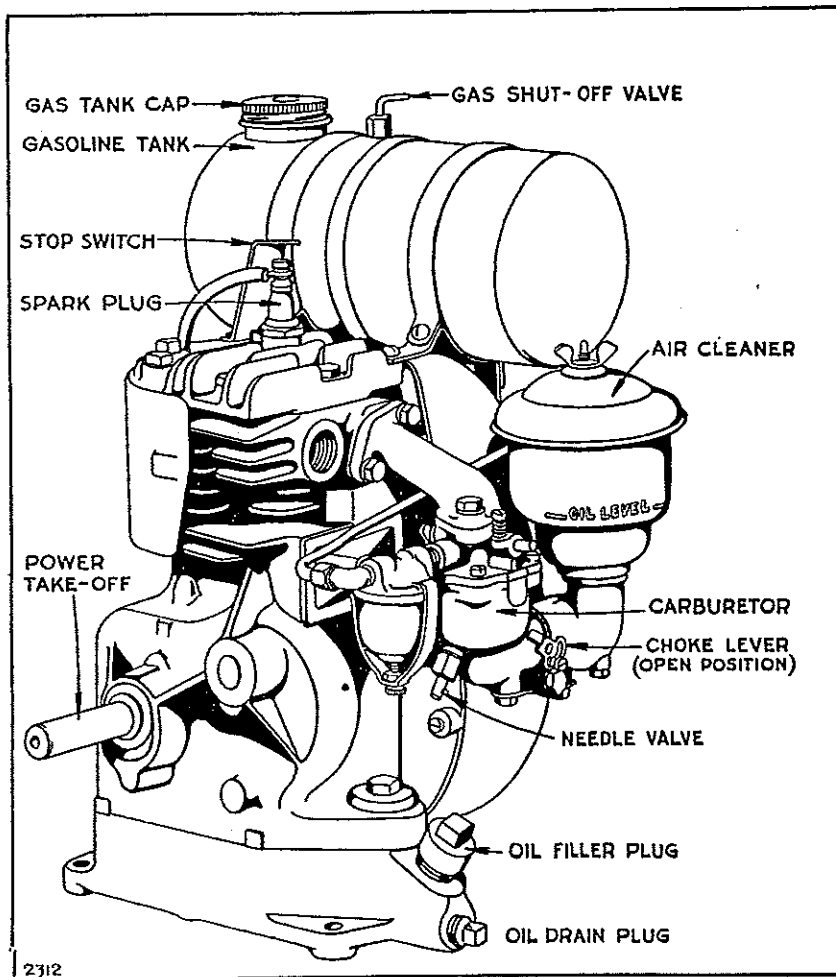

Z712

# Servicing Reference Chart

## MOTOR FAILS TO START

	Paragraph
Out of Gasoline.....	1-16
Out of Oil.....	1-13-54-55
Dirt or Gum in Fuel System.....	16 to 19
Incorrect Use of Choke.....	20
Carburetor Out of Adjustment.....	22 to 26
Spark Plug Dirty.....	30-31
Ignition Cable Grounded.....	32
Magneto.....	33 to 41
Poor Compression.....	42 to 51
Air Cleaner Clogged.....	57

## MOTOR STOPS

Out of Gasoline.....	1-16
Out of Oil.....	1-13-54-55
Dirt or Gum in Fuel System.....	18 to 19
Motor Overheated.....	13-54-55-56-57-58-59
Air Cleaner Clogged.....	57
Motor Overloaded.....	59

## MOTOR OVERHEATS

	Paragraph
Out of Oil.....	1-13-54-55
Oil Needs Changing.....	14-15
Oil Too Heavy.....	14-15
Carburetor Out of Adjustment.....	22 to 26
Poor Spark.....	29 to 41
Carbon.....	56
Muffler Clogged.....	58
Overloaded.....	59

## MOTOR LACKS POWER

Lack of Oil.....	1-13-54-55
Add or Change Oil.....	13 to 15
Carburetor Out of Adjustment.....	22 to 26
Motor Not Up to Speed.....	22 to 28
Poor Spark.....	29 to 41
Poor Compression.....	42 to 51
Carbon.....	56
Air Cleaner Clogged.....	57
Muffler Clogged.....	58
Overloaded.....	59

# Instructions for Adjustment and Repair

	Paragraph
Operating Requirements.....	8
How a 4-Cycle Motor Operates.....	10
Keep the Motor Clean.....	11
Use the Right Kind of Oil.....	12
Add Oil Regularly.....	13
Change Oil Frequently.....	14
Use Clean Gasoline.....	16
Avoid Gummy Gasoline.....	17
To Clean the Fuel Lines.....	19
Correct Use of the Choke.....	20
To Prime the Motor.....	21
To Adjust the Carburetor.....	22
To Remove and Replace Carburetor.....	25
To Clean Carburetor.....	26
Governor—Correct Motor Speed.....	27
Governor Speed Adjustment.....	28
The Ignition System.....	29
To Check for Spark.....	30
Spark Plug Adjustment.....	31
Ignition Cable.....	32
To Remove and Replace Flywheel.....	33

	Paragraph
To Remove and Replace Magneto Assembly.....	35
Magneto Timing.....	36
To Adjust and Clean Contact Points.....	37
To Replace Condenser.....	38
To Replace and Adjust Armature.....	40
Cylinder Head.....	42
Compression.....	43
Valve Adjustment.....	44
Crankshaft.....	48
Piston.....	49
Piston Rings.....	51
Piston Pin.....	52
Connecting Rod.....	53
Oil Pumps.....	54
Oil Leaks.....	55
Carbon.....	56
Air Cleaner.....	57
Muffler.....	58
Overload.....	59
Starter Pedal.....	60
Starter Clutch.....	60
Parts.....	62

5. **GENERAL DATA.** You will find your motor substantially built. It is made of high grade materials by skilled workmen, in a factory fully equipped with the most modern machinery. Before it was shipped, it received many tests and careful inspections.

6. Your motor will give you better service if you do not tinker with it. This does not mean, however, that it does not require a certain amount of attention. Give it the right kind of fuel, oil and care. Keep it clean both inside and out. You will be well repaid in trouble-free, satisfactory service.

7. If you should experience any difficulty, follow the instructions referred to in the Servicing Reference Chart above. If you cannot easily remedy it, consult your dealer or a nearby Briggs & Stratton Authorized Central Service Distributor, see page 19.

8. **OPERATING REQUIREMENTS.** A gasoline motor to operate properly must have all parts in correct adjustment to provide good ignition, carburetion, compression and cooling. And of equal importance, the oil and gasoline used must be clean and of recommended grades. The following instructions fully explain the simple adjustments and offer operating recommendations that will assure you of complete satisfaction. We urge you to carefully observe them.

9. The reliability, economy and ease of starting which characterize this motor are due in part to the fact that it is of the 4-stroke cycle design commonly called "4-cycle," the same design used in all automotive motors. As the name indicates, there are four strokes to one complete power cycle.

**10. HOW A 4-CYCLE MOTOR OPERATES.** On the intake stroke the piston goes down, producing a vacuum in the cylinder, thereby drawing fuel up through the carburetor so that the space above the piston becomes filled with combustible gas. During this stroke the intake valve is open. Next the piston comes up on the compression stroke with both valves closed. At the top of the compression stroke a spark occurs at the spark plug, firing the highly compressed gas. This produces an explosion above the piston which forces it down on the power stroke. Both valves are closed. On the next upstroke of the piston, called the exhaust stroke, the exhaust valve is open, and the burned gases driven out. See plate No. 2.

The 4-Stroke Cycle — Plate No. 2

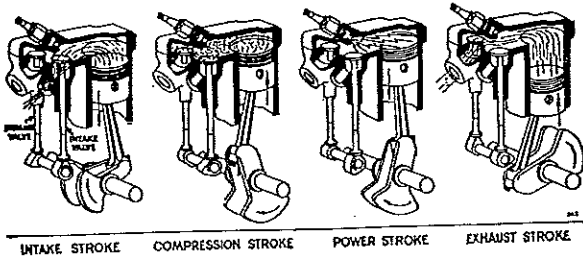

**11. KEEP THE MOTOR CLEAN.** It will pay you to keep your motor clean both inside and outside. See that no dirt or water enters motor when filling with oil or gasoline. As a precautionary measure always wipe off the gasoline cap and oil filler plug, as well as around them before refilling. Dirt in the motor or gasoline tank will cause trouble and even serious damage. Also be sure to remove any dirt or grass that may accumulate in the flywheel housing or between cylinder fins.

**12. USE THE RIGHT KIND OF OIL.** Correct lubrication is important. We recommend the use of Mobiloil Arctic or other high grade oil with similar characteristics having a low carbon residue and a body not heavier than S.A.E. No. 20 for operating motor in temperature of 32° F. and above. For temperatures below 32° F. use Mobiloil "Arctic Special" or other high grade oil not heavier than S.A.E. No. 10W. A heavier oil which might be satisfactory in a tractor or for lubricating farm machinery must NOT be used. Do not mix oil with the gasoline. This 4-cycle motor is provided with an independent efficient pump lubrication system which forces a stream of oil to all moving parts of the motor. There are no external parts which require separate oiling.

**13. ADD OIL REGULARLY.** A motor which is run without oil will be ruined within a few minutes. To avoid the possibility of such an occurrence and the resulting expense, always fill the oil reservoir at the blue plug to the top of the filler plug opening after each five hours of motor operation. Capacity of oil reservoir is 1 pint.

**14. CHANGE OIL FREQUENTLY.** After every twenty-five hours of motor operation, the oil should be completely drained from the crankcase. Do not remove motor from its mounting base. Remove the yellow oil drain plug, located at either end of motor base, and let the oil flow into a pan or other receptacle you use. We do not recommend flushing out with kerosene. Replace the drain plug, refill with fresh oil and replace the blue filler plug.

**15.** In the normal running of any motor, small particles of metal from the cylinder walls, pistons and bearings will gradually work into the oil. Dust particles from the air also get into the oil. If the oil is not changed regularly these foreign particles cause

increased friction and a grinding action which shortens the life of the motor. Sludge, a gummy mass, forms which clogs up the oil passages. Fresh oil also assists in cooling, for old oil gradually becomes thick and loses its cooling as well as its lubricating qualities.

**16. USE CLEAN GASOLINE.** A good grade of clean, fresh gasoline is recommended. Too high test gasoline may form vapor-lock in gas line when motor gets hot. This interrupts the flow of gasoline and causes motor to stop. Be sure that the small vent hole in the gasoline tank cap is not clogged up, for air must enter the tank to allow the gasoline to flow to the carburetor. Test by blowing through top of cap. See paragraph 18.

**17. AVOID GUMMY GASOLINE.** If you experience trouble with a gummy, sticky substance with a peculiar sharp obnoxious smell, change to another grade of gasoline. This gum comes from the gasoline and clogs carburetor, gas line, gasoline tank, etc. You can check your gasoline by evaporating a half pint in an open dish. If a quantity of gum remains, try another kind that is clean and fresh.

**18. YOU CAN AVOID MOST TROUBLE FROM GUM IF YOU WILL KEEP THE TANK FULL WHEN YOU ARE NOT USING THE MOTOR.** If you use it only occasionally, drain tank completely and refill when motor is used again. The reason for this is that evaporation of stale gasoline causes most gum deposits.

**19. TO CLEAN THE FUEL LINES.** Close the gas shut-off valve on top of gas tank, turn valve to right. Disconnect gas line at gas filter and also at the gas tank. Blow through the gas line to clear it. To clean the gas filter, loosen thumb screw below gas filter bowl. Remove and clean filter bowl and screen. Blow through the gas passage in the cover. Open shut-off valve to see if gasoline flows freely from the tank. **IMPORTANT:** If you find a gummy, varnish-like substance use alcohol or acetone to dissolve it. See paragraphs 17 and 18.

**20. CORRECT USE OF THE CHOKE.** The correct carburetor setting (see paragraph 23) gives the motor the best mixture to run on when it is hot. For starting, it is necessary to choke the carburetor to get a rich mixture, because cold gasoline does not vaporize readily. A warm or hot motor requires very little choking. Until you become familiar with your motor, however, you may make the mistake of not choking the carburetor enough or you may choke it too much. If motor fails to start after cranking three or four times with the choke closed, try cranking two or three times with the choke part-way down and then all the way down, or open. Use motor choke the same as you use an automobile choke.

**21. TO PRIME THE MOTOR.** The motor may fail to start for the reason that either the carburetor is incorrectly adjusted or dirty, or the fuel line is dirty or clogged, or you are out of gasoline. To determine the cause, prime the motor by removing the spark plug and pour a half teaspoonful of gasoline into the spark plug opening. Replace the spark plug and crank the motor. If it fires for three or four revolutions and stops, the difficulty is definitely in the fuel system. See paragraphs 19, 22 to 26. If motor will not fire at all, check the ignition system, see paragraphs 29 to 41, also compression, paragraphs 42 to 51.

**22: TO ADJUST THE CARBURETOR.** The carburetor on this motor is of the gravity type. The gasoline supply is regulated by a needle valve. The throttle is automatically controlled by the governor, see paragraphs 27 and 28.

**23.** To adjust the carburetor, completely close needle valve by turning to right or clockwise as far as possible. Do not screw up

too tight or use force when closing needle valve, or needle valve may be damaged. From closed position, open needle valve one-half to three-quarter turn. After the motor has been started and warmed up make final adjustment with the choke wide open by turning the needle valve to the point at which motor operates most smoothly with full load. This setting will also take care of starting with use of the choke. When starting cold motor, if it is necessary to keep choke partially closed several minutes before motor runs smoothly, carburetor setting is too lean and needle valve should be opened a notch or two—turn to left. For governor adjustments see paragraphs 27 and 28.

**23A.** The idle adjustment screw setting is about a half to three quarters of a turn open. Do not force screw against seat or you will damage both. See plate No. 3, Fig. A.

**24.** The throttle lever adjusting screw is set at the factory to permit an idling speed of about 1600 R.P.M. We do not recommend adjusting the throttle to bring the speed lower. If you want to idle the motor at a higher speed than 1600 R.P.M. turn the throttle lever adjusting screw to the right or in a clockwise direction.

**25. TO REMOVE AND REPLACE CARBURETOR.** Close shut-off valve on top of gas tank, disconnect gasoline line from gas filter. Remove air-cleaner and elbow, unhook throttle and control return spring, loosen carburetor and unhook throttle link. To replace, reverse the operations as performed above.

**Carburetor and Air Vane Governor Hook-Up—Plate No. 3**

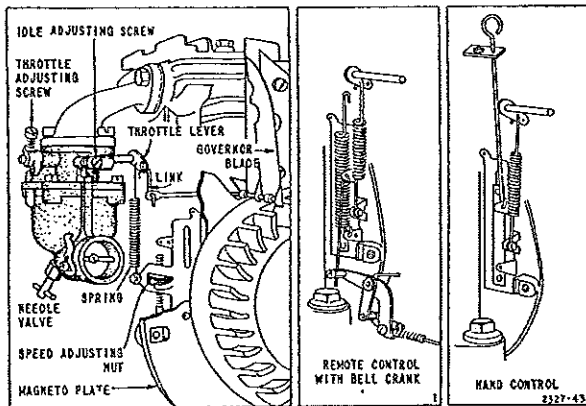

Fig. A

Fig. B

Fig. C

**Carburetor and Mechanical Governor Hook-Up—Plate No. 3A**

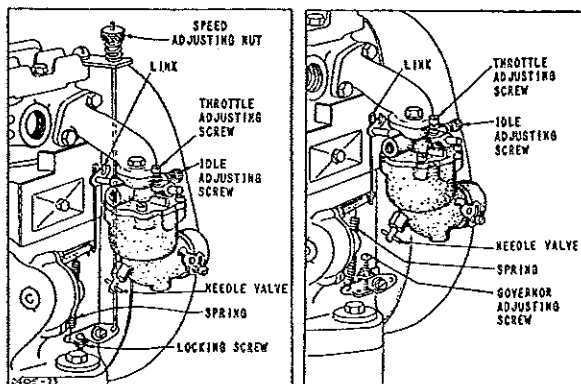
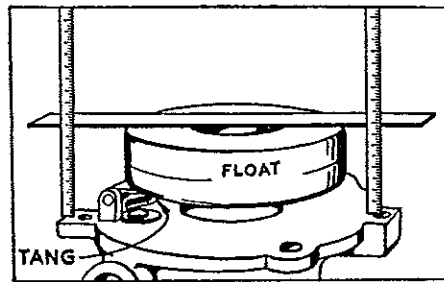

Fig. A

Fig. B

**26. TO CLEAN CARBURETOR.** Remove it from the motor as explained in the previous paragraph. Remove gas line connector elbow. To disassemble carburetor, FIRST remove needle valve, stuffing box nut, packing nut gland and nozzle. Then remove

**Carburetor Float Position.—Plate No. 3B**



screws and lockwashers from the upper carburetor body. **CAUTION:** The upper and lower bodies are interlocked by the nozzle and failure to disassemble in above order will result in damaged parts. To check inlet valve and seat, pull out brass pin holding carburetor float. A worn or dirty inlet valve and seat or incorrect float level will cause carburetor to leak. In reassembling, float should be in a horizontal position when it closes inlet valve and seat. To check float, invert upper carburetor body and place a scale or a flat straight piece of steel across carburetor float and see that distance from top of float to carburetor body flange is equal at both sides of float. See plate No. 3B. The float hinge tang can be bent to attain proper position of float. If any parts are gummy, clean them in alcohol or acetone. Blow through all passages and openings. Do not use wire to clean out small holes. Replace worn or damaged parts.

**27. GOVERNOR—CORRECT MOTOR SPEED.** The speed of this motor is automatically maintained under varying loads by a built-in governor. It was carefully adjusted at the factory and should not be re-adjusted unless absolutely necessary. Recommended operating speed is 2600 to 3600 R.P.M. As different types of equipment require various operating speeds for the greatest efficiency, it is suggested that you follow the recommendations of the manufacturer of the complete unit which the motor powers.

**28. GOVERNOR SPEED ADJUSTMENT.** Two distinctly different types of governors are used on different types of motors:

1. Air vane governor, which operates by the air current blown by the flywheel. (See plate No. 3.)
2. Mechanical governor, which is built into crankcase and is gear driven off of cam gear. (See plate No. 3A.)

To adjust, proceed as follows:

(a) **Air Vane Type:**

1. **Fixed Speed Control.** (See plate No. 3, Fig. A.) A speed adjuster is located beneath carburetor on magneto plate. To increase motor speed turn speed adjusting thumb nut down. To decrease speed turn thumb nut up.
2. **Manual Speed Control.** (See plate No. 3, Fig. B.) To increase motor speed pull lever so that swivel moves away from control lever boss. To decrease speed push lever so that swivel moves toward control lever boss.

Some models are equipped with a hand governor control. To increase motor speed pull up on knob, to decrease speed push knob down. See insert in plate No. 3, Fig. C.

(b) **Mechanical Type.** Two types of speed adjustment devices are used:

1. Speed adjustment nut located on end of control rod which extends above cylinder. (See plate No. 3A, Fig. A.) To increase speed, turn speed adjustment nut down. To reduce speed, turn speed adjustment nut up.
2. Speed adjustment screw located below carburetor. (See plate 3A, Fig. B.) To increase speed, loosen lock nut and turn governor adjusting screw down. To reduce speed, turn screw up. Tighten lock nut.

**29. THE IGNITION SYSTEM.** The spark is produced by a high tension magneto consisting of armature, condenser, contact points and rotating magnets cast in a flywheel. This is a simple self-contained system which is very reliable. It also does away with batteries. The ignition current is sent into the motor cylinder through the ignition cable and spark plug. The magneto itself as well as the cable and spark plug must all be in proper condition and adjustment to insure a good hot spark.

**30. TO CHECK FOR SPARK.** To prove that a satisfactory spark is being delivered by the magneto, remove the ignition cable from the plug. Hold ignition cable terminal about  $\frac{1}{8}$ " from any metal part of the cylinder head (keep hand on insulated part of the

Checking Spark  
Plate No. 4

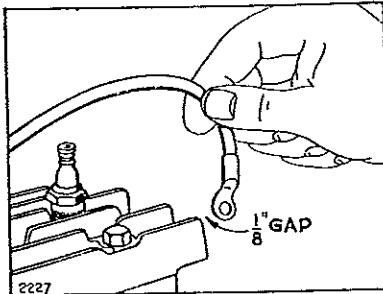

Spark Plug  
Plate No. 5

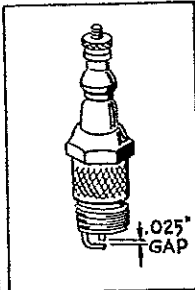

cable to avoid a shock). Turn motor with starter, and if the spark jumps this gap the entire ignition system, with the exception of the spark plug, is O. K. See plate No. 4. (To check spark plug see paragraph 31.) If no spark, check cable, see paragraph 32, and refer to magneto adjustments paragraphs 33 to 41.

**31. SPARK PLUG ADJUSTMENT.** Spark plugs should be cleaned and points reset to .025" after each 100 hours of operation. See plate No. 5. Points burn away in service. The porcelain is to prevent the spark from jumping anywhere except at the gap, and if cracked or broken it will prevent the plug firing. Water on the outside of the spark plug may permit the high voltage current to leak over the surface of the porcelain. Dirt or carbon on it will do the same thing. The spark plug can be cleaned by washing off the carbon with gasoline or kitchen scouring powder. Points should be scraped or sand-papered. See plate No. 5. Always keep a new plug on hand. We recommend the use of Champion No. J8 or its exact equivalent. When reassembling spark plug to cylinder head put a little graphite grease on threads. Do not get grease on points.

**32. IGNITION CABLE,** Insulation must not be broken or soaked with oil or water or grounded in any way where it touches the motor, or it will interfere with good ignition. To check cable all the way to magneto it is necessary to remove blower case. Ignition cable should be securely wound to the secondary terminal loop of the coil. See plate No. 9.

**33. TO REMOVE AND REPLACE FLYWHEEL.** The flywheel is securely mounted to the crankshaft by means of a taper fit, a key, a LEFT-hand nut and spring washer, or a threaded clutch housing and locking plate.

**A. Rope Starter Motors.** Remove the blower housing. Bolt or clamp motor to work bench. Place a wood block under flywheel fin on right side of flywheel or a small rod between fins to hold it rigid and prevent turning as you loosen nut. See Fig. 1, Plate No. 6. Use large wrench, 10 inch or bigger. To start nut to the RIGHT tap end of wrench handle lightly with hammer. Tap carefully or a broken fin may result which will throw flywheel out of balance. After nut is re-

moved, loosen flywheel by placing the wood block against end of crankshaft and striking with a hammer. Pull off flywheel.

**B. Hand Lever and Foot Starter Motors.** On models with die cast clutch housing and starter pinion on side toward motor, remove starter assembly, loosen set screw and slip clutch housing from shaft, remove blower housing and proceed to remove flywheel as in "A." See Fig. 2, Plate No. 6.

On models with cast iron clutch housing and starter pinion away from motor, remove starter assembly and blower housing. Bend locking tang out of clutch housing recess with screw driver. To remove clutch housing tap to right with a punch and hammer; then proceed to remove flywheel as in "A." See Fig. 3, Plate No. 6.

**34. To reassemble,** locate flywheel on crankshaft with key and install spring washer with the hollow or concave side next to the flywheel. Turn nut to LEFT until tight. Then use block under fin on left side of flywheel or rod between fins to hold flywheel rigid and draw nut or clutch housing very tight by tapping with hammer.

Removing Flywheel  
Plate No. 6

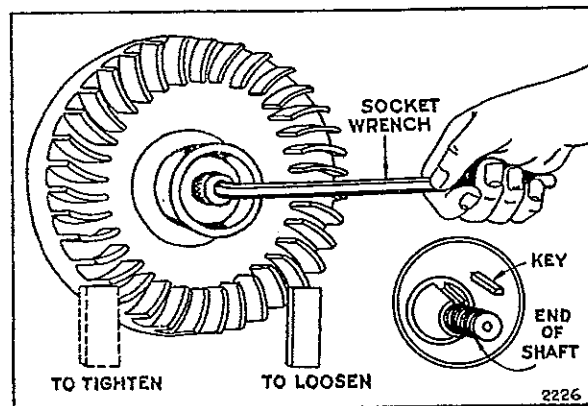

Fig. 1

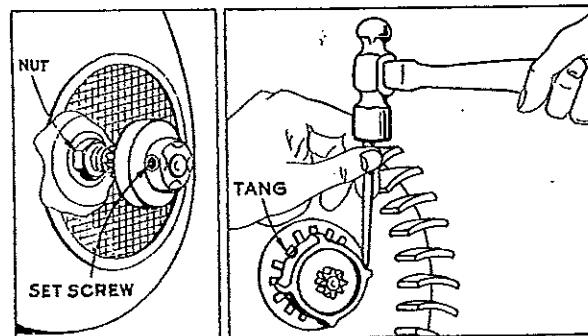

Fig. 2

Fig. 3

**35. TO REMOVE AND REPLACE MAGNETO ASSEMBLY.** After removing the flywheel as explained in paragraph 33, remove magneto point dust cover. If carburetor has not been removed, it is not necessary to do so. Remove governor air vane from armature. Unhook governor spring from speed adjusting slide plate. Detach ignition cable from spark plug. Remove four magneto plate mounting screws. To replace, use same gasket between plate and crankcase, or if damaged, a new gasket, see part number 67307, 67597, 67607 for proper thickness to get correct end play of .002" to .008" between magneto bearing and crankshaft thrust faces, as shown in plate No. 7. Use lockwashers under mounting screws.



**36. MAGNETO TIMING.** The magneto assembly is always correctly timed with the motor when the flywheel is assembled to the tapered crankshaft with a key and securely held in place with left hand threaded nut or cast iron clutch housing. Do not attempt to change the timing by relocating any parts or filing crankshaft timing flat. Always use soft key part No. 61760. If steel key is used and flywheel becomes loose it will damage the keyway in the crankshaft.

Correct End Play  
Plate No. 7

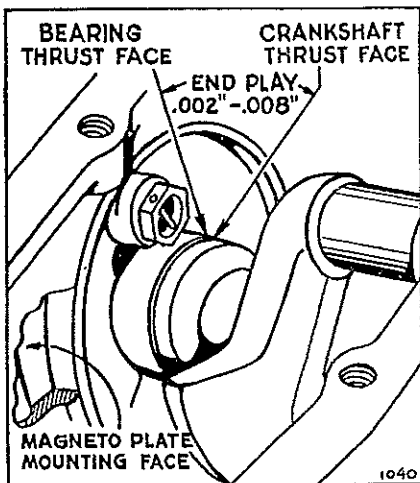

**37. TO ADJUST AND CLEAN CONTACT POINTS.** Remove blower housing, flywheel and magneto point dust cover. Turn crankshaft by hand to see if contact points open and close properly. Points must be clean and line up squarely to make good electrical contact. Do not file contact points — use fine sand paper or fine grit hone to clean points. Adjust gap to .020" by loosening the adjust-

Contact Points and Condenser  
Plate No. 8

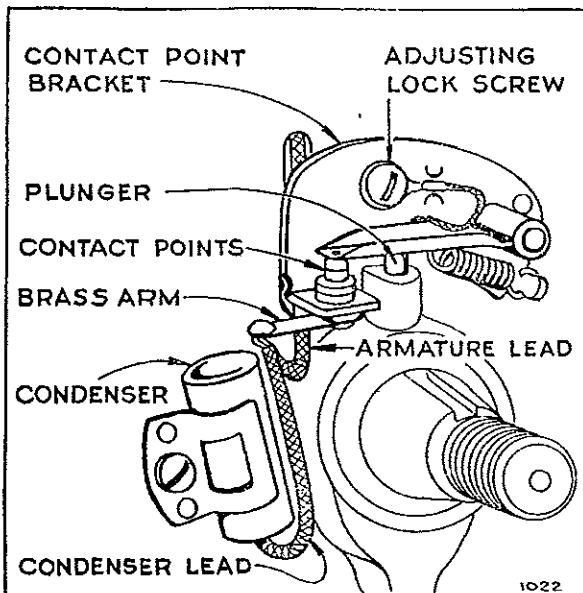

ing lock screw and moving contact point bracket up or down. When proper gap is obtained tighten lock screw securely. If either or both points become badly pitted or burned and need replacement, always order complete assembly Part No. 29667.

**38. TO REPLACE CONDENSER.** A leaky or weak condenser may cause the motor to start hard, to sputter or misfire under

load. If motor misfires after checking gasoline line, carburetor, spark plug, cable and contact points, install a new condenser. Both the condenser lead and armature lead must be soldered to brass arm, see plate No. 8. Be sure to push condenser lead down between condenser and hub of magneto plate so it cannot rub against flywheel.

**39.** If after new condenser has been installed the ignition system still does not deliver a satisfactory spark, we recommend sending the complete magneto unit including flywheel to the nearest Briggs & Stratton Authorized Central Service Distributor listed on page 19.

**40. TO REPLACE AND ADJUST ARMATURE.** Remove primary armature lead wire of coil from brass arm on contact bracket. Remove high tension ignition cable from secondary terminal loop in coil. Unscrew four armature mounting screws. After installing new armature be sure that condenser lead wire and armature lead wire from coil are soldered to brass arm on contact bracket. See plates Nos. 8 and 9. Replace mounting screws, inserting loop of ground wires under screw and draw screws up tight.

**41.** Air gap of .008" to .012" must be maintained between armature core ends and flywheel. Gap must only be sufficient to prevent rubbing, but not over .012", or poor ignition will result. To adjust gap to proper clearance, loosen the four armature mounting screws, slide armature assembly up and place correct feeler gauge or three thicknesses of newspaper between rim of flywheel and armature core ends. Lower armature assembly until core ends rest on gauge or paper and tighten mounting screws securely. See plate No. 9.

**42. CYLINDER HEAD.** The cylinder head is held on with six cap screws. When the cylinder head has been removed for the purpose of cleaning carbon or grinding valves, care should be used in replacing it. Use a new gasket if possible. Otherwise, clean the old one and coat both sides with cup grease. We do not recommend the use of shellac on cylinder head gaskets.

Complete Magneto Assembly  
Plate No. 9

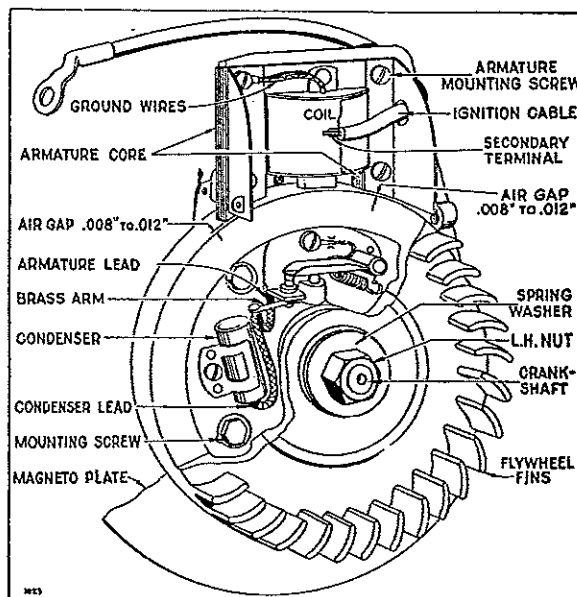

Tighten each cap screw a little at a time so that the cylinder head is pulled down evenly. Screws need be only moderately tight.

**43. COMPRESSION.** Proper compression is obtained when valves seat properly, gaskets do not leak, and piston and rings are properly fitted. When tuning up a motor, it is always well to

check compression. This is done by turning the motor over quickly by hand. If turned slowly sticky valves may not be detected. If a point of resistance is offered every other revolution, compression should be satisfactory. If motor turns over without compression resistance for a full cycle, it is possible that a worn piston or piston rings, leaky valves or leaky gaskets are present. See that spark plug has a gasket under it and is drawn up tight. Also check cylinder head gasket and tighten cylinder head bolts.

**44. VALVE ADJUSTMENT.** To check valve clearance remove valve cover plate. The correct clearance on the exhaust valve is .015", and on the intake valve .008" when motor is cold. Tappet clearance is adjusted by grinding required amount from end of valve stem. End of stem must be square with stem proper.

**45.** To remove valves, remove cylinder head, and if not dismantled, drain oil from crankcase. Invert cylinder. Compress the spring with a screw driver and pull out valve retainer pin with

Valve Timing — Plate No. 10

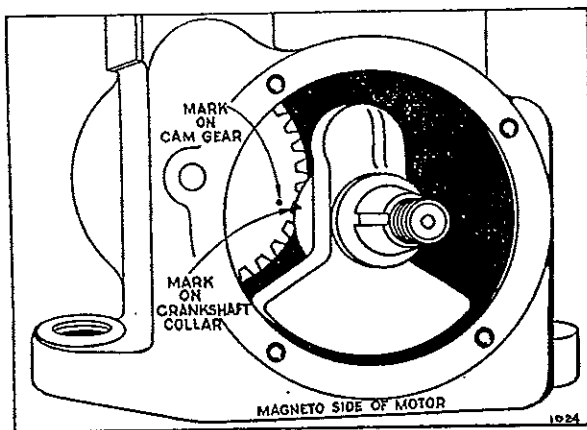

long nose pliers. Tilt cylinder back far enough to allow valve to drop, permitting its stem to clear the spring. Pry the spring out with screw driver. To replace, reverse the operations as performed above.

**46.** To reset valves, grind in the same manner as automobile valves. If valves stick they may be coated with gum or carbon. To remove gum use alcohol or acetone. Clean valve stems thoroughly with wire brush or emery cloth. Also scrape all carbon from valve ports.

**47.** The timing of the valves is taken care of by the meshing of the cam shaft gear with the gear on the crankshaft. These gears are properly meshed when the mark on the cam shaft gear is in line with the mark on the crankshaft collar. See plate No. 10.

**48. CRANKSHAFT.** To remove crankshaft, FIRST remove magneto plate from motor and connecting rod from crankshaft. Then carefully slip crankshaft out toward magneto side of motor. To reassemble, reverse the operation.

**49. PISTON.** The piston in this motor is made of a special aluminum alloy which is very light in weight. The clearance between the piston and cylinder wall is .0045" to .0065". The lands of the piston are smaller than the skirt to allow for greater expansion at the piston head. This clearance is to compensate for the expansion of aluminum when hot. When piston is removed be sure to clean carbon from head of piston and ring grooves. The top groove of the piston does not have a piston ring. It is a "Heat Insulating Groove." If piston is out of round or scored it should be replaced.

**50.** If an oversize piston is necessary, we recommend that re-boring of cylinder be done by an Authorized Central Service Distributor or the factory.

**51. PISTON RINGS.** The piston rings when fitted in the cylinder should have a gap of .007" to .017". The rings should be fitted in the cylinder below the piston ring travel. Before assembling new rings to piston be sure that piston ring grooves are thoroughly cleaned and rings move in grooves freely.

**52. PISTON PIN.** The piston pin is a slip fit in the piston. To remove it from the piston, first remove lock rings, then slip pin out of piston.

**53. CONNECTING ROD.** The connecting rod is also made of a special aluminum alloy which combines strength with light weight. When assembling connecting rod to crankshaft, the cam gear clearance flat must be toward the magneto side. See plate No. 11, Fig. 1. The assembly marks on cap and rod must be opposite clearance flat as shown in Fig. 1. It is equipped with locking plates. The tang of this plate must fit in slot and the plate bent against the hexagon head of the cap screws. See Fig. 2.

Connecting Rod — Plate No. 11

Fig. 1

Fig. 2

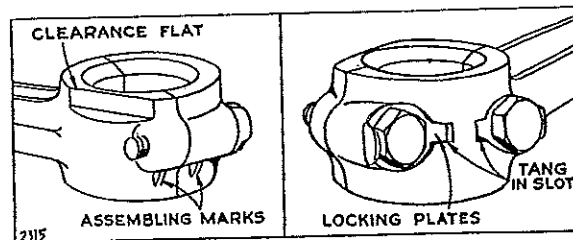

**54. OIL PUMPS.** Oil pumps are of two types, "Plunger" and "Gear." Both types are assembled to the base. An inoperative pump will result in insufficient lubrication which may score the cylinder and piston assembly. Test pumps as follows:

**"A" Plunger Type.** Remove from base. Place pump in a pan of oil about 1/2-inch deep. Work plunger up and down. If oil is sprayed out, oil pump is in good working condition. If clogged, submerge complete unit in gasoline or kerosene for three or four hours to loosen accumulated sludge or gum. If still inoperative it should be replaced. In assembling be sure that spring and plunger are in place.

Plunger Type Oil Pump — Plate No. 12

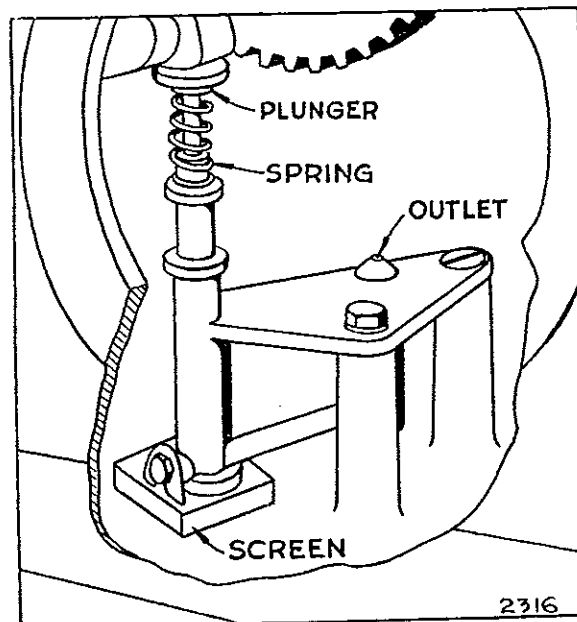

Gear Type Oil Pump — Plate No. 12A

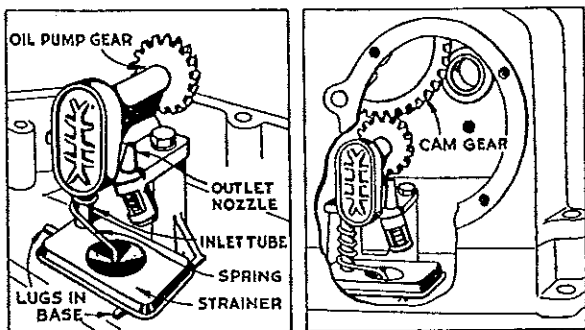

Fig. 1

Fig. 2

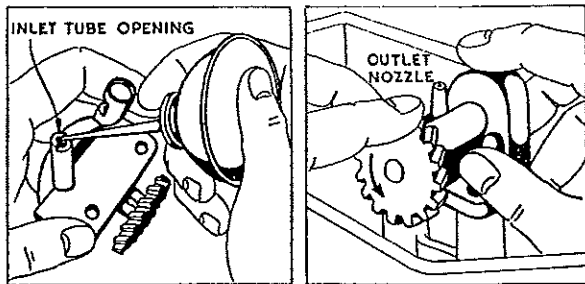

Fig. 3

Fig. 4

**"B" Gear Type.** (See Plate No. 12A.) Remove pump from base. Slip strainer and spring from inlet tube. Clean strainer in gasoline or kerosene to remove accumulated sludge and gum. To test the pump hold it with end of inlet tube submerged in oil and spin the gear with fingers in a counter-clockwise direction. If oil is sprayed from outlet nozzle, the pump is in good working order. If it fails to function, submerge pump in kerosene for three or four hours to loosen any gum or sludge which may have accumulated inside the pump.

A pump that has been washed or soaked in kerosene must first be primed or lubricated before it is operated again so that it will start pumping the instant the gear begins to turn. This is done by running oil into inlet tube opening. A DRY pump will not function immediately. An inoperative pump must be replaced. **CAUTION:** Do NOT apply compressed air to this pump at any time nor should any attempt be made to disassemble it. When assembling pump to base be sure that strainer is resting on lugs in bottom of base and the hold down spring is in place. When assembling base to cylinder be sure that gear teeth of pump are properly meshed with cam gear teeth. See plate No. 12A, Figs. 1 to 4.

**55. OIL LEAKS.** If oil leaks from either end of crankshaft main bearings, remove base from motor. Oil return valves are screwed into crankcase and magneto back plate below main bearings. Remove oil return valve and clean or flush with gasoline and blow out any dirt lodged under the small disc. Replace if necessary. See plate No. 7.

**58. CARBON.** Excessive carbon is caused by improper grade of oil—too much oil usually the result of piston rings not seating properly or sticking—carburetor set too rich—or long service. An unusual amount of carbon is noticeable by motor knocking or loss of power. Occasionally remove carbon from valves, valve ports, piston head, piston rings and ring grooves, cylinder head and top of cylinder bore.

**57. AIR CLEANER.** The air cleaner is to protect the motor from dust and dirt. No motor can stand up under the grinding action that takes place when dust and dirt particles are drawn into the motor through the carburetor. Clean the air cleaner occasionally

by removing it and washing in kerosene. Test it to see if it is clogged by blowing through it or noting if motor performs better with it off. If clogged it should be replaced. Keep the oil level up to the heading. See instructions on air cleaner label.

**58. MUFFLER.** After long periods of service it is possible that the muffler will become clogged to the point where it will affect the motor's power. To check the muffler unscrew it from the motor and run water into the open end of the muffler. If full streams of water come out of the small holes at the end of the muffler, you will know that it is not clogged up. If the water runs through very slowly, however, the muffler is probably clogged and should be replaced.

**59. OVERLOAD.** Always be sure that the machine the motor is operating is well lubricated and running freely. If it is not, it may cause the motor to become overloaded resulting in it overheating, losing power, or even stopping entirely.

**60. STARTER PEDAL ADJUSTMENT.** Should the starter pedal return spring, on motors with the starter on the power takeoff side, loosen or lose its tension, loosen the bolt which holds the return spring cup. See plate No. 13. Turn the cup to the left until there is just enough tension to return the starter pedal back to the normal position after depressing it, and tighten the bolt. Too much tension may cause spring to break. Be sure the spring is in the proper position with the long end below the pedal adjusting bolt and the hooked end in the slot of the cup.

**61. STARTER CLUTCH.** If the starter clutch slips or fails to turn the motor, when stepping on the starter pedal, it is probably caused by one of the following reasons:

- Loose set screw.
- Worn clutch housing.
- Worn or broken pinion.

First tighten the set screw to be sure clutch is tight on the crankshaft. Use  $\frac{1}{8}$ " Allen hexagon set screw wrench. If the clutch still slips, loosen set screw and remove clutch from the shaft. Pry out the snap spring with a sharp tool, holding the clutch in the position shown in plate No. 14, as a precaution against the spring jumping out. Check the parts carefully for wear or damage and replace those necessary. To reassemble, replace the parts in the same order, and slip the spring back in place. Replace pulley clutch on shaft with the set screw hole lined up with recess in crankshaft extension. Securely tighten set screw.

Starter Pedal Adjustment — Plate No. 13

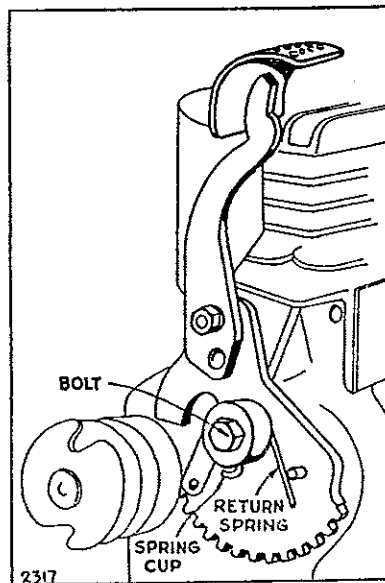

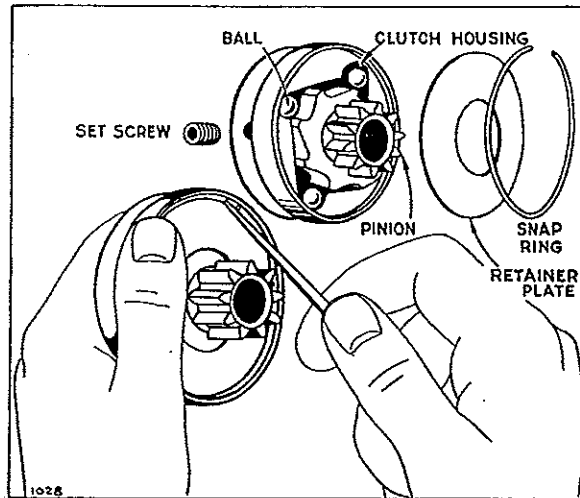

**62. PARTS.** All parts should be ordered from your dealer or the nearest Briggs & Stratton Service Distributor listed on page 19.

## Repair Parts

Paraph	Page
Always Give Type, Model and Serial Number	64
How to Make Out Parts Orders.....	66
How to Find Correct Part Number.....	11
Parts List .....	11-16
Parts Illustrations .....	17-18

**63.** To assure continued satisfactory performance, do not attempt to use substitute repair parts when overhauling or repairing the Briggs & Stratton Motor. Insist that all repair parts be original Briggs & Stratton parts.

**64. ALWAYS GIVE TYPE, MODEL AND SERIAL NUMBERS.** Briggs & Stratton motors are identified by a type number, model letter and a serial number. This information is stamped on a metal plate attached to the blower housing.

**65.** When writing to the factory or to a Central Service Distributor for service information, or when ordering new parts, be sure to specify the type number, the model, and the serial number of the motor to be serviced. This will assure prompt and efficient service without unnecessary correspondence.

**66. HOW TO MAKE OUT PARTS ORDERS.** Print your name and address plainly and correctly. Do not abbreviate name of

town or state. Specify on the order how shipment to you is to be made. This will assist in giving prompt and efficient service.

**67.** Give part numbers and name of parts wanted. (Do not use number cast on parts.) You will find the part numbers, names and prices on pages 11-16, and parts illustrations on pages 17-18.

**68.** After you have made out order, check back to see that you have followed all instructions and have accurately listed what you want.

**69.** Shipments will be made C.O.D. or send remittance with order to cover parts and add what you think will be sufficient for postage. Send postal or express money order, bank draft or certified check for this amount. Do not send currency in a letter. It is not safe.

Briggs & Stratton Gasoline Motors are precision built and require original Briggs & Stratton replacement parts in order to obtain satisfactory results. Service that is not reliable or continuous becomes expensive at any price.

Users will find that the prices paid for original repair parts are well worth the investment when the service delivered is compared with that afforded by substitute parts. Original Briggs & Stratton repair parts can be obtained through all Authorized Central Service Distributors listed on page 19.

## TO FIND THE CORRECT NUMBER OF THE PART YOU NEED

1. Make a note of your motor TYPE NUMBER (Not the Serial Number) that appears on the metal nameplate attached to motor blower housing.
2. Refer to pages illustrating parts and locate the Master Part Number by comparing your old part with the illustrations. Assemblies include all part numbers bracketed in illustration. All parts shown in assembly brackets on which part numbers are given can be purchased separately.
3. After the Master Part Number has been identified, refer to the following Parts List where these Master Part numbers are listed in numerical order.  
The Master Part is used on all types of motors except those types listed under "Note."
4. If a "Note" appears below the Master Part Number, this means that this part is made different from the Master Part for certain types and if your type is listed under "Note," order the part referred to.
5. If two or more parts are bracketed (—) under "Note," they are used to replace the Master Part on the type numbers shown.
6. If your Motor Type Number does not appear after any part number listed under "Note," order the Master Part Number.
7. When ordering parts—or writing for service information—always specify the MODEL LETTER—TYPE NUMBER—and SERIAL NUMBER of your motor.

## Parts List

MODELS "N"—"NF"—"NR"

MASTER PART NUMBER	NAME	SHIPPING WEIGHT Lbs. Oz.	MASTER PART NUMBER	NAME	SHIPPING WEIGHT Lbs. Oz.
21090	Plate—Generator End	1	22153	Bracket—Control Rod	1
	Note: No. 21458 Plate—Generator End. Used on type No. 205282.	1	22182	Washer—Clutch Retainer	1
21110	Venturi—Carburetor	1	22206	Shield—Cylinder	6
21129	Body—Lower Carburetor	6	22216	Cover—Breather	1
	Note: No. 99720 Body—Lower Carburetor Used on type Nos. 205108, 205125, 205150, 205170, 205177.	6	22217	Shield—Oil Spray	1
	Includes: { No. 90193 Screw—Machine, Fill. Hd.—6-32x <sup>3</sup> / <sub>8</sub> "	1	22221	Cover—Valve	6
	{ No. 90362 Lockwasher—No. 6x <sup>3</sup> / <sub>8</sub> x <sup>1</sup> / <sub>2</sub> "	1	22233	Plate—Spark Plug Shield Support	1
21174	Elbow—Air Cleaner	12	22238	Washer—Cylinder Mounting	1
	Note: No. 21611 Elbow—Air Cleaner. Used on type No. 205291.	12	22243	Washer—Cylinder Mounting	1
21283	Ring—Piston, Compression, Top—Standard	1	22247	Bushing—Cylinder	2
21310	Body—Breather	1	22252	Washer—Thrust (.065" Thick)	1
21362	Head—Cylinder	2	22279	Brace—Air Cleaner Elbow	1
	Note: No. 21356 Head—Cylinder. Used on type Nos. 205084, 205108, 205125.	2	22281	Bracket—Bell Crank	3
	No. 21400 Head—Cylinder. Used on type Nos. 205105, 205161, 205166, 205182, 205183, 205306, 205314.	2	22353	Washer—Valve Cover	1
21376	Ring—Piston, Compression, Top—.010" O.S.	1	22368	Washer—Control Lever	1
21377	Ring—Piston, Compression, Top—.020" O.S.	1	22384	Washer—Thrust (.075" Thick)	1
21378	Ring—Piston, Compression, Top—.030" O.S.	1	22508	Bushing—Gear Case	2
21453	Lever—Hand Starter	1	22520	Cup—Gear Case	1
	Note: No. 21373 Lever—Hand Starter Used on engines before Serial No. 23482 replaced by No. 89600 Starter Assembly.	1	22522	Stop—Speed Adjusting	1
21737	Elbow—Air Cleaner	12	22725	Washer—Control Lever	1
21752	Elbow—Carburetor Intake	6	22834	Washer—Control Lever	1
22031	Lock—Clutch Housing	2	23059	Lever—Fuel Shut-off	2
22032	Washer—Needle Valve Packing	1	23062	Bushing—Intermediate Gear	2
22036	Valve—Throttle	1	23068	Nut—Speed Adjusting	1
22050	Valve—Choke	1	23069	Screw—Speed Adjusting	1
22062	Washer—Choke Lever	1	23075	Spacer—Foot Pedal Support	1
22082	Lock—Connecting Rod Screw	1	23077	Pinion—Starter	4
22084	Brace—Air Cleaner Elbow	1		Note: No. 63794 Pinion—Starter. Used on type Nos. 205082, 205084, 205108, 205125, 205269.	4
22125	Brace—Air Cleaner Elbow	1	23104	Spacer—Foot Pedal Support	1
			23114	Pin—Float Hinge	1
			23125	Pin—Throttle Stop	1
			23184	Retainer—Valve Spring	1
			23187	Pin—Valve Spring Retainer	1
			23222	Nozzle—Carburetor	1
			23227	Nut—Needle Valve Packing	1
			23228	Valve—Idle Adjusting	1
			23230	Bushing—Throttle Shaft	1
			23250	Stud—Starter Mounting	3
			23270	Screw—Choke Lever	1
			23277	Key—Drive Pulley	1
			23282	Bolt—Air Cleaner	2
				Note: No. 23334 Stud—Air Cleaner. No. 90355 Nut—Hex.—10-32.	1

(See following page)

THIS BOOK COVERS TYPE NUMBERS 205000 TO 205499 ONLY

MASTER PART NUMBER	NAME	SHIPPING WEIGHT Lbs. Oz.	MASTER PART NUMBER	NAME	SHIPPING WEIGHT Lbs. Oz.
	No. 92290 Lockwasher—No. 10x-1/8x3/4" .....	1		205143, 205145, 205146, 205154, 205156, 205162, 205186, 205190.	
	Used on type Nos. 205062, 205063, 205071, 205104, 205111, 205164, 205275.			No. 26353 Crankshaft.....	3
	No. 23711 Stud—Air Cleaner.....	3		Used on type Nos. 205065, 205066, 205117, 205170, 205258.	
	No. 92290 Lockwasher—No. 10x-1/8x3/4" .....	1		No. 26357 Crankshaft.....	3
	No. 90355 Nut—Hex.—10-32.....	1		Used on type No. 205054.	
	Used on type No. 205291.			No. 26359 Crankshaft.....	3
	No. 290039 Stud—Air Cleaner....	4		Used on type Nos. 205084, 205108, 205125, 205269.	
	Used on type No. 205274.			No. 26362 Crankshaft.....	3
23329	Bushing—Starter Support .....	2		Used on type Nos. 205092, 205166, 205182, 205282, 205306, 205310, 205314, 205315.	
23386	Valve—Intake .....	2		No. 26378 Crankshaft.....	3
23388	Pinion—Starter .....	4		Used on type Nos. 205075, 205076, 205079, 205088, 205105, 205106, 205115, 205118, 205119, 205123, 205128, 205133, 205140, 205147, 205150, 205152, 205153, 205165, 205169, 205180, 205181, 205184, 205185, 205254.	
23443	Pin—Dowel .....	1		No. 26382 Crankshaft.....	3
23444	Stud—Valve Cover .....	1		Used on type Nos. 205086, 205144.	
23468	Rod—Throttle Control .....	1		No. 26383 Crankshaft.....	3
23571	Swivel—Control Lever .....	1		Used on type Nos. 205094, 205141, 205171, 205272, 205313, 205317.	
23580	Bushing—Control Lever .....	1		No. 26492 Crankshaft.....	3
23663	Valve—Exhaust .....	2		Used on type Nos. 205192, 205303.	
23681	Pinion—Drive .....	6		[No. 23158 Sleeve—Bearing.	1
23692	Rod—Push .....	1		Uses: [No. 23666 Locknut.....	1
23729	Lever—Fuel Shut-off .....	3		[No. 62980 Washer—Sleeve.	1
23911	Bushing—Gear Cover .....	2		No. 26499 Crankshaft.....	3
26021	Spring—Intake Valve .....	1		Used on type Nos. 205270, 205274, 205280, 205291.	
26025	Spring—Pedal Return .....	1		26374 Link—Throttle .....	1
26026	Lock—Piston Pin .....	1		26391 Link—Throttle .....	1
26032	Spring—Clutch Retainer .....	1		26393 Spring—Governor .....	1
26048	Casing—Control Wire—38" long.....	8		26404 Washer—Stop Switch .....	1
	Note: If a longer casing is needed, specify in inches; if a shorter casing is needed order No. 26048 and cut to required length.			26478 Spring—Exhaust Valve .....	1
				26483 Spring—Stop Switch Push Rod.....	1
26152	Spring—Pedal and Lever Return.....	1		26485 Spring—Oil Pump .....	1
26157	Spring—Idle Valve and Throttle Adj..	1		Used on engines beginning with type No. 205250.	
26172	Spring—Pump Plunger .....	1		27043 Gasket—Engine Base .....	1
26178	Spring—Pedal Return .....	1		27045 Gasket—Intake Elbow Mounting.....	1
26228	Spring—Choke Lever Return.....	1		27108 Washer—Starter Lever .....	1
26229	Spring—Choke Lever .....	1		27110 Gasket—Gear Cover (.010" Thick).....	1
26267	Spring—Control Wire Return.....	1		27111 Gasket—Gear Cover (.005" Thick).....	1
	Note: No. 26358 Spring—Control Wire Return .....	1		27138 Gasket—Gear Case Cover.....	1
	Used on earlier model engines where spring is hooked through hole in magneto plate.			27139 Gasket—Gear Case Mounting.....	1
26269	Spring—Starter Pedal Return.....	2		27323 Gasket—Breather Body .....	1
26330	Spring—Breather Retainer .....	1		29226 Cup—Oil .....	1
26351	Crankshaft .....	3		29667 Point Assembly—Contact .....	2
	Note: No. 26316 Crankshaft.....	3		29671 Armature—Magneto .....	2
	Used on type Nos. 205052, 205053, 205085, 205101, 205107, 205124, 205168, 205172, 205175, 205177, 205178, 205179, 205252, 205279, 205294, 205308.			29693 Plug—Spark (with Gasket).....	3
	No. 26324 Crankshaft.....	3		29806 Gasket—Spark Plug .....	1
	Used on type Nos. 205055, 205056, 205059, 205062, 205071, 205077, 205081, 205083, 205089, 205098, 205102, 205104, 205110, 205116, 205134, 205135, 205148, 205151, 205157, 205158, 205163, 205164, 205167, 205191, 205194, 205264, 205265, 205283, 205287, 205297, 205298, 205299, 205300, 205309, 205311.			29835 Flywheel—Magneto .....	6
	No. 26329 Crankshaft.....	3		29861 Condenser .....	2
	Used on type Nos. 205064, 205067, 205078, 205095, 205136, 205159, 205193, 205257, 205273, 205284, 205288, 205296, 205304, 205318.			29878 Rope—Starter .....	6
	No. 26343 Crankshaft.....	3		38852 Washer—Armature .....	1
	Used on type Nos. 205063, 205275.			46133 Spring—Spark Plug Shield.....	1
	No. 26352 Crankshaft.....	3		61703 Gear—Cam .....	1 8
	Used on type Nos. 205057, 205058, 205061, 205072, 205073, 205080, 205082, 205096, 205097, 205122, 205129, 205130, 205132, 205137,			61756 Ring—Piston, Compression, Center—Standard .....	1
				61757 Ring—Piston, Oil—Standard .....	1
				61760 Key—Flywheel .....	1
				Note: No. 21103 Key—Flywheel.....	1
				Used on type No. 205084.	
				61768 Ring—Piston, Compression, Center—.010" O.S. ....	1
				61769 Ring—Piston, Compression, Center—.020" O.S. ....	1
				61770 Ring—Piston, Compression, Center—.030 O.S. ....	1
				61771 Ring—Piston, Oil—.010" O.S.....	1

Before ordering parts, read instructions top page 11

THIS BOOK COVERS TYPE NUMBERS 205000 TO 205499 ONLY

MASTER PART NUMBER	NAME	SHIPPING WEIGHT Lbs. Oz.	MASTER PART NUMBER	NAME	SHIPPING WEIGHT Lbs. Oz.
61772	Ring—Piston, Oil—.020" O.S.....	1	89221	Cap—Fuel Tank .....	2
61773	Ring—Piston, Oil—.030" O.S.....	1		Note: No. 29860 Cap—Fuel Tank (Red)...	2
61947	Housing—Starter Clutch .....	10		Used on type No. 205137.	
	Note: No. 21100 Housing—Starter Clutch	14		No. 89961 Cap—Fuel Tank.....	2
	Used on type Nos. 205082, 205084,			Used on type Nos. 205090, 205099,	
	205108, 205125, 205269.			205128, 205181, 205182, 205185,	
61967	Stop—Throttle .....	1		205192, 205269, 205273, 205285,	
62473	Shim—.005" thick .....	1		205294, 205303, 205306.	
62474	Shim—.010" thick .....	1		No. 89988 Cap—Fuel Tank.....	2
62536	Cup—Starter Return Spring.....	1		Used on type Nos. 205274, 205291.	
62538	Washer—Clutch Retainer .....	2	89345	Cap—Oil Filler .....	2
62552	Bushing—Cylinder .....	2	89002	Pulley Assembly—Automatic Drive....	2
62577	Washer—Flywheel .....	1	89115	Rod—Connecting .....	8
	Note: No. 62903 Washer—Flywheel....	1	89127	Clutch Assembly—Starter .....	1
	Used on engines with foot or hand			Note: No. 89706 Clutch Assembly —	
	lever starters on magneto side.			Starter .....	3 8
62693	Pulley—Rope Starter .....	6		Used on type No. 205177.	
62835	Cover—Dust .....	8		No. 89739 Clutch Assembly —	
62842	Spacer—Dust Cover .....	1		Starter .....	3 8
62851	Strap—Fuel Tank .....	3		Used on type Nos. 205179, 205279.	
	Note: No. 62965 Strap—Fuel Tank.....	2	89128	Pump Assembly—Oil (Plunger Type)....	1
	Used on type Nos. 205090, 205099,			Used on engines before type No.	
	205128, 205181, 205182, 205185,			205250.	
	205273, 205285, 205288, 205294,		89190	Pipe—Fuel—13" long .....	3
	205303, 205306.			Note: For other lengths specify:	
62876	Screen—Fuel Filter .....	1		No. 69419 Pipe—Fuel—13" long..	3
62891	Wrench—Spark Plug and Filler Cap....	4		Used on type No. 205269.	
62966	Switch—Stop .....	2		No. 89503 Pipe—Fuel—11 $\frac{3}{4}$ " long	3
63426	Locknut—Control Wire Casing.....	1		Used on type Nos. 205158, 205179,	
63770	Bail—Clutch .....	1		205279, 205287.	
63771	Bushing—Starter Sector .....	1		No. 89520 Pipe—Fuel—12 $\frac{3}{4}$ " long	3
63785	Shaft—Cam .....	3		Used on type Nos. 205090, 205099,	
63788	Tappet—Valve .....	1		205128, 205181, 205182, 205185,	
63965	Plunger—Oil Pump .....	1		205190, 205192, 205273, 205285,	
65704	Plunger—Contact Point .....	1		205294, 205303, 205306.	
65794	Insulator—Armature .....	1		The following Fuel Pipes and	
65968	Disc—Breather Valve .....	1		Connections used to mount No.	
66111	Elbow—Fuel Pipe .....	1		99510 Combination Tank on	
	Note: No. 92291 Nut—Tubing.....	1		type No. 205137:	
	No. 23572 Sleeve—Tubing.....	1		No. 89615 Valve—Shut-off.....	2
	Used with elbow on type No.			No. 89226 Pipe—Fuel—11 $\frac{1}{2}$ "	
	205318.			long .....	3
66114	Washer—Cylinder Mounting .....	1		No. 89509 Pipe—Fuel—4 $\frac{1}{2}$ "	2
66154	Washer—Stop Switch .....	1		long .....	2
66164	Washer—Stop Switch .....	1		No. 89511 Tee.....	1
66432	Washer—Speed Adjuster Retainer and	1		No. 290160 Pipe—Fuel—9" long..	3
	Fuel Tank Strap.....	1		Used on type No. 205270.	
	Note: No. 67072 Washer—Fuel Tank			No. 290161 Pipe—Fuel—13" long.	3
	Strap .....	1		Used on type No. 205274.	
	Used on type Nos. 205090, 205099,		89241	Blade—Governor .....	6
	205128, 205181, 205182, 205185,		89274	Shaft Assembly—Drive .....	3 8
	205190, 205273, 205285, 205288,			Note: No. 89330 Shaft Assembly—Drive	
	205292, 205294, 205303, 205306.			Used on type Nos. 205062, 205164,	
67016	Wire—Control—42" long .....	2		205297.	
	Note: If longer wire is needed, specify			No. 89441 Shaft Assembly—Drive	3 8
	length in inches; if shorter wire			Used on type Nos. 205096, 205097,	
	is needed order No. 67016 and			205098, 205104, 205129, 205130,	
	cut to required length.			205134, 205135, 205146, 205190.	
67307	Gasket—Magneto Plate—.015" thick....	1	89280	Cylinder .....	14
67527	Gasket—Valve Cover .....	1		Note: No. 89393 Cylinder.....	14
67537	Gasket—Cylinder Head .....	1		Used on type Nos. 205055, 205056,	
67597	Gasket—Magneto Plate—.005" thick....	1		205057, 205058, 205059, 205061,	
67607	Gasket—Magneto Plate—.009" thick....	1		205062, 205071, 205072, 205073,	
68122	Plug—Cam Shaft .....	1		205077, 205080, 205081, 205082,	
68477	Gasket—Fuel Filter Bowl.....	1		205083, 205089, 205096, 205097,	
68487	Bowl—Fuel Filter .....	2		205098, 205102, 205104, 205110,	
68507	Washer—Fuel Shut-off Valve Packing...	1		205116, 205122, 205129, 205130,	
68537	Gasket—Gear Cover—.015" thick.....	1		205132, 205134, 205135, 205137,	
68857	Gasket—Carburetor Body .....	1		205143, 205145, 205146, 205148,	
68877	Gasket—Fuel Inlet Valve Seat.....	1		205151, 205154, 205156, 205157,	
68887	Packing—Needle Valve .....	1		205158, 205162, 205163, 205164,	
68897	Gasket—Carburetor Venturi .....	1		205167, 205186, 205190, 205191,	
68957	Gasket—Air Cleaner Mounting.....	1		205194, 205264, 205265, 205283,	
68987	Gasket—Carburetor Mounting .....	1		205287, 205297, 205298, 205299,	
				205300, 205309, 205311.	
				No. 89401 Cylinder .....	14
				Used on type Nos. 205063, 205064,	
				205065, 205066, 205067, 205078.	
				(See following page)	

Before ordering parts, read instructions top page 11

THIS BOOK COVERS TYPE NUMBERS 205000 TO 205499 ONLY

MASTER PART NUMBER	NAME	SHIPPING WEIGHT Lbs. Oz.	MASTER PART NUMBER	NAME	SHIPPING WEIGHT Lbs. Oz.
	205084, 205086, 205092, 205094, 205095, 205108, 205117, 205125, 205136, 205141, 205144, 205159, 205166, 205170, 205171, 205182, 205193, 205257, 205258, 205269, 205272, 205273, 205275, 205282, 205284, 205288, 205296, 205304, 205306, 205310, 205313, 205314, 205315, 205317, 205318.			No. 89447 Housing—Blower..... 2 Used on type Nos. 205090, 205099, 205128, 205149, 205174, 205181, 205182, 205185, 205190, 205192, 205198, 205273, 205285, 205294, 205303, 205306.	
	No. 89465 Cylinder..... 14 Used on type No. 205111.			No. 290167 Housing—Blower..... 2 Used on type Nos. 205284, 205310.	
	No. 89913 Cylinder..... 14 Used on type Nos. 205192, 205303.		89495	Body Assembly—Upper Carburetor..... 4 Note: No. 89735 Body Assembly—Upper Carburetor ..... 4 Used on Engines before Serial No. 79294.	
	Includes: { No. 91648 Screw—Cap, 1 Hex. Hd.— $\frac{1}{8}$ -24x $\frac{1}{2}$ " 1 No. 91865 Lockwasher.. 1		89600	Starter Assembly—Hand ..... 3	
	No. 89975 Cylinder..... 14 Used on type Nos. 205270, 205274, 205280, 205291.		89611	Sector Assembly—Starter ..... 14 Note: No. 89363 Sector Assembly..... 14 Used on engines with Hand Lever Starters before Serial No. 23482.	
89283	Piston Assembly—.010" O.S..... 8		89613	Cover Assembly—Gear ..... 3 8 Note: No. 89670 Cover Assembly—Gear 3 8 Used on type Nos. 205062, 205164, 205297.	
89285	Piston Assembly—.020" O.S..... 8		89615	Valve—Fuel Shut-off ..... 3	
89287	Piston Assembly—.030" O.S..... 8		89660	Seal—Oil ..... 1 Used on engines after Serial No. 20000. Note: No. 23495 Ring—Oil Retainer.... 1 Used on engines before Serial No. 20000.	
89289	Piston Assembly—Standard ..... 8		89676	Pump—Oil (Gear Type)..... 8 Used on engines beginning with type No. 205250.	
89298	Gear—Intermediate ..... 1 Note: No. 89442 Gear—Intermediate.... 1 Used on type Nos. 205096, 205097, 205098, 205104, 205129, 205130, 205134, 205135, 205146, 205190.		89677	Bushing—Crankshaft ..... 3 Includes: No. 89660 Seal—Oil. Used on engines after Serial No. 20000. Note: No. 89340 Bushing—Crankshaft.. 2 Includes: No. 23495 Ring—Oil Retainer. Used on engines before Serial No. 20000.	
89307	Valve—Oil Return ..... 1			No. 99158 Bearing—Ball..... 8 No. 99176 Seal—Oil..... 6 Used on all engines with Ball Bearing Drive Side Bearing not otherwise listed in this note. No. 99440 Seal—Oil..... 6 Used on type No. 205192, 205303.	
89363	Sector Assembly—Starter ..... 14 Note: No. 89611 Sector Assembly — Starter ..... 14 Used on type No. 205177.		89694	Rod Assembly—Choke ..... 1 Note: No. 29876 Rod Assembly—Choke. 1 Used on type No. 205269. No. 69452 Wire—Choke..... 1 Used on type No. 205150.	
89365	Starter Assembly—Foot ..... 3		89688	Screen—Oil Pump ..... 1 Used on engines beginning with type No. 205250.	
89383	Base—Engine (Cast Iron)..... 6 Note: No. 89362 Base—Engine (Cast Iron) 6 Used on type Nos. 205055, 205067, 205071, 205077, 205083, 205103, 205104, 205110, 205124, 205151, 205167.		89742	Shield—Spark Plug ..... 6	
	No. 89402 Base—Engine (Cast Iron) 6 Used no type Nos. 205057, 205058, 205065, 205066, 205075, 205076, 205084, 205088, 205096, 205097, 205106, 205117, 205128, 205133, 205137, 205140, 205145, 205150, 205156, 205165, 205170, 205181, 205184, 205185, 205186, 205190.		89838	Wrench—Spark Plug ..... 6	
	No. 89407 Base—Engine (Cast Iron) 6 Used on type Nos. 205062, 205070, 205081, 205091, 205095, 205109, 205111, 205113, 205116, 205120, 205126, 205127, 205135, 205136, 205148.		89889	Base—Engine (Cast Iron)..... 6 Note: No. 89879 Base—Engine (Cast Iron) 6 Used on type Nos. 205268, 205278, 205287, 205292, 205300, 205302, 205317.	
	No. 89408 Base—Engine (Cast Iron) 6 Used on type Nos. 205061, 205072, 205073, 205079, 205080, 205086, 205108, 205115, 205130, 205132, 205143, 205146, 205147, 205152, 205169, 205193.			No. 89881 Base—Engine (Cast Iron) 6 Used on type Nos. 205254, 205258. No. 89885 Base—Engine (Cast Iron) 8 Used on type No. 205277. No. 89887 Base—Engine (Cast Iron) 8 Used on type No. 205309. No. 89891 Base—Engine (Cast Iron) 8 Used on type Nos. 205269, 205304.	
	No. 89409 Base—Engine (Cast Iron) 6 Used on type Nos. 205085, 205087, 205158, 205159, 205163, 205172, 205174, 205177, 205189.		89966	Muffler ..... 1 8 Note: No. 89945 Muffler..... 1 8 Used on type Nos. 205273, 205289. No. 99866 Muffler..... 1 8 Used on type No. 205071.	
	No. 89436 Base—Engine (Cast Iron) 6 Used on type Nos. 205082, 205123, 205125, 205144, 205153, 205154.		89970	Case Assembly—Gear ..... 12	
	No. 89451 Base—Engine (Cast Iron) 6 Used on type Nos. 205105, 205118, 205119, 205122, 205129, 205162, 205180.		89976	Seal—Oil ..... 8	
89386	Housing—Blower ..... 2 Note: No. 22889 Housing—Blower..... 2 Used on type Nos. 205084, 205108, 205125, 205269, 205270, 205274, 205319.		90029	Screw—Machine, Rd. Hd.—4-36x $\frac{1}{4}$ ".... 1	

Before ordering parts, read instructions top page 11



THIS BOOK COVERS TYPE NUMBERS 205000 TO 205499 ONLY

MASTER PART NUMBER	NAME	SHIPPING WEIGHT Lbs. Oz.	MASTER PART NUMBER	NAME	SHIPPING WEIGHT Lbs. Oz.
90066	Screw—Machine, Rd. Hd.—8-32x1/4"....	1		No. 91812 Elbow—Muffler.....	3
90067	Screw—Machine, Rd. Hd.—8-32x3/8"....	1		Used on type Nos. 205055, 205071, 205111, 205163, 205274.	
90072	Screw—Machine, Rd. Hd.—8-32x5/8"....	1			
90079	Screw—Machine, Rd. Hd.—10-32x3/8"....	1	91811	Locknut—Muffler Elbow .....	2
	Note: No. 91366 Screw—Machine, Rd. Hd.—10-32x7/8" .....	1	91833	Stud—Dust Cover .....	1
	No. 90321 Nut—Square—10-32... ..	1	91896	Key—No. 5 Woodruff.....	1
	Used on type Nos. 205090, 205099, 205128, 205181, 205182, 205185, 205190, 205192, 205273, 205285, 205288, 205294, 205303, 205306.		91901	Screw—Cap, Hex. Hd.—7/8-20x1 1/2"....	1
90081	Screw—Machine, Rd. Hd.—10-32x1/2"....	1	91920	Screw—Machine, Fill. Hd.—8-32x5/8"....	1
90083	Screw—Machine, Rd. Hd.—10-32x3/8"....	1	91984	Pin—Cotter—7/8x1/2" .....	1
	Note: No. 90321 Nut—Square—10-32... ..	1	91991	Screw—Set .....	1
	Used with above Screw on type Nos. 205090, 205099, 205128, 205181, 205182, 205185, 205190, 205192, 205273, 205285, 205288, 205294, 205303, 205306.		92017	Screw—Machine, Fill. Hd.—8-32x3/8"....	1
90200	Screw—Machine, Fill. Hd.—8-32x1/2"....	1	92040	Nut—Jam .....	3
90202	Screw—Machine, Fill. Hd.—10-32x1/2"....	1	92051	Nut—Castle—7/8-20 .....	1
90313	Nut—Hex.—8-32 .....	1	92054	Nut—Starter Pedal .....	1
90337	Nut—Hex., Brass—8-32 .....	1	92067	Nut—Wing .....	1
90355	Nut—Hex.—10-32 .....	1	92089	Screw—Machine, Fill. Hd.—1/4-20x3/4"....	1
90364	Lockwasher—No. 8x3/4x3/8" .....	1	92125	Screw—Cap, Hex. Hd.—1/4-20x1/2"....	1
90366	Lockwasher—7/8x1/2x1/8" .....	1		Note: No. 91422 Screw—Cap, Hex. Hd.—1/4-20x5/8" .....	1
90367	Lockwasher—No. 8x3/4x3/8" .....	1		Used on type Nos. 205062, 205164.	
90369	Lockwasher—No. 4x3/4x3/8" .....	1	92129	Nut—Hex.—1/4-28 .....	1
90528	Screw—Cap, Hex. Hd.—1/4-28x3/4"....	1	92208	Screw—Connecting Rod .....	1
90686	Screw—Cap, Hex. Hd.—3/8-24x1"....	1	92211	Lockwasher (Shakeproof No. 1514).....	1
	Note: No. 91541 Screw—Cap, Hex. Hd.—7/8x24x7/8" .....	1	92227	Lockwasher (Shakeproof No. 1120).....	1
	Used on Hand Lever Starter engines before Serial No. 23482.		92228	Screw—Cap, Flat Head—1/4-20x5/8"....	1
90688	Screw—Cap, Hex. Hd.—7/8-24x1 1/4"....	1	92235	Screw—Cylinder Mounting .....	1
90810	Screw—Machine, Fill. Hd.—1/4-20x3/4"....	1	92236	Screw—Cylinder Mounting .....	1
90832	Lockwasher—1/4x3/4x3/8" .....	1	92278	Nut—Hex.—1/4-20 .....	1
90844	Lockwasher—1/4x1/2x1/8" .....	1	92285	Pin—Cotter—No. 18x1/4" .....	1
90847	Nut—Hex.—1/4-28 .....	1	92287	Screw—Machine, Rd. Hd.—10-32x1/4"....	1
90849	Pin—Cotter—3/8x3/4" .....	1	92290	Lockwasher—No. 10x1/2x3/8" .....	1
90916	Screw—Machine, Rd. Hd.—1/4-20x1/2"....	1	92291	Nut—Shut-off Valve, Packing.....	1
	Note: No. 91691 Screw—Machine, Fill. Hd.—1/4-20x5/8" .....	1	92292	Nut—Hex.—3/8-24 .....	1
	For Blower Housing on type No. 205291.			Note: No. 91208 Nut—Hex. 7/8-24.....	1
90950	Screw—Cap, Hex. Hd.—7/8-24x3/4"....	1		Used on Hand Lever Starter engines before Serial No. 23482.	
91070	Lockwasher (Shakeproof) No. 1208.....	1	92305	Washer—Control Lever (1/8" Thick)....	1
91084	Plug—Pipe—3/8" .....	1	92306	Screw—Cap, Hex. Hd.—1/4-28x5/8"....	1
	Note: No. 90878 Plug—Pipe, 1/4".....	1		Note: No. 90802 Screw—Cap, Hex. Hd.—1/4-20x1 1/2" .....	1
	Used on engines equipped with bases which have 1/4" pipe threaded oil drain hole.			No. 92278 Nut—Hex.—1/4-20.....	1
91208	Nut—Hex.—7/8-24 .....	1		Used to mount control lever to lever base on type Nos. 205071, 205083, 205104, 205151.	
91237	Lockwasher—1/4x3/4x3/8" .....	1	92424	Screw—Machine, Fill. Hd.—1/4-20x1 1/2"....	1
91324	Washer—1/4" Standard.....	1	92425	Nut—Square—1/4-20 .....	1
91401	Screw—Machine, Fill. Hd.—8-32x1/4"....	1	92502	Screw—Cap, Hex. Hd.—7/8-24x1 3/8"....	1
91413	Pin—Cotter—1/2x1" .....	1	92612	Lockwasher (Shakeproof No. 1228).....	1
91419	Screw—Cap, Hex. Hd.—1/4-20x5/8"....	1	92644	Rivet—Tubular—1/8x3/8" .....	1
91449	Screw—Cap, Hex. Hd.—7/8-18x1 1/8"....	1		Note: No. 62575 Spring—Speed Adjuster Used on type No. 205063.	1
91456	Screw—Cap, Hex. Hd.—1/4-20x1"....	1	92646	Pin—Cotter—1/2x1 1/2" long .....	1
91539	Key—7/8" Sq. ....	1	99082	Pedal—Foot Starter .....	1
91541	Screw—Cap, Hex. Hd.—7/8-24x7/8"....	1	99158	Bearing—Ball .....	8
91691	Screw—Machine, Fill. Hd.—1/4-20x5/8"....	1		Note: No. 89977 Bearing—Ball.....	8
91708	Nut—Flywheel Mounting .....	1		Used on type Nos. 205270, 205274, 205280.	
	Note: No. 91900 Nut—Flywheel Mounting .....	1	99176	Seal—Oil .....	6
	Used on engines with foot or hand lever starters on magneto side.			Note: No. 99440 Seal—Oil.....	6
91711	Screw—Cylinder Head (Short).....	1		Used on type Nos. 205192, 205303.	
91741	Screw—Pedal Return Spring Cup.....	1	99180	Tank Assembly—Fuel .....	3
91753	Screw—Machine, Fill. Hd.—8-32x1/4"....	1		Note: No. 29034 Tank—Fuel (1 Gallon)..	3
91758	Screw—Set, Sock, Hd.—7/8-24x1/2"....	1		Used on type Nos. 205090, 205099, 205128, 205181, 205182, 205185, 205190, 205192, 205269, 205273, 205285, 205294, 205303, 205306.	
91796	Screw—Cap, Hex. Hd.—7/8-24x1 3/4"....	1		No. 89987 Tank—Fuel.....	3
91808	Lockwasher—7/8x3/4x1/8" .....	1		Used on type Nos. 205274, 205291.	
91810	Elbow—Muffler .....	3		No. 99510 Tank—Combination Fuel	3
	Note: No. 91523 Nipple—Exhaust.....	2		Used on type No. 205137.	
	Used on type No. 205269.		99243	Handle—Carrying .....	
			99272	Clutch Assembly—Starter .....	1
				Note: No. 99615 Clutch Assembly — Starter .....	1
				Used on type Nos. 205082, 205084, 205108, 205125, 205269.	

Before ordering parts, read instructions top page 11

THIS BOOK COVERS TYPE NUMBERS 205000 TO 205499 ONLY

MASTER PART NUMBER	NAME	SHIPPING WEIGHT Lbs. Oz.	MASTER PART NUMBER	NAME	SHIPPING WEIGHT Lbs. Oz.
99288	Cable—Ignition .....	2		No. 290062 Control Assembly—Throttle .....	
	Note: No. 89805 Cable—Ignition.....	3		Used on type No. 205269.	
	Used on type Nos. 205179, 205279.		290584	Base—Control Lever (Stamped Steel)....	2
	No. 99391 Cable—Ignition.....	3		Note: No. 65631 Base—Control Lever...	4
	Used on type Nos. 205105, 205161, 205166, 205182, 205183, 205284, 205306, 205310, 205314.			Used on type Nos. 205071, 205083, 205104, 205151.	
99306	Pedal & Sector—Foot Starter.....	1	290642	Lever—Control (Stamped Steel).....	2
99307	Starter Assembly—Foot .....	3	290763	Magneto Assembly .....	6
99317	Seal—Oil .....	6		Note: No. 290764 Magneto Assembly...	6
99339	Starter Assembly—Hand Lever.....	3		Used on type Nos. 205118, 205120, 205129, 205134, 205135, 205137, 205150, 205155, 205165, 205168, 205191, 205269, 205289, 205295, 205308, 205320.	
99390	Shield—Spark Plug .....	6		No. 42215 Connector... 1	
99621	Valve—Needle Adjusting .....	3		Includes: No. 66104 Insulator... 1	
99622	Float—Carburetor .....	2		No. 66205 Wire—Ground 1	
99630	Cleaner Assembly—Air .....	1		No. 290765 Magneto Assembly... 6	
	Note: No. 89376 Cleaner Assembly—Air	1		Used on type Nos. 205179, 205279.	
	Used on type Nos. 205079, 205153.			No. 290766 Magneto Assembly... 6	
	No. 89980 Cleaner Assembly—Air	1		Used on type Nos. 205192, 205303.	
	Used on type Nos. 205274, 205291.			No. 290767 Magneto Assembly... 6	
99632	Tooth Assembly—Spring .....	1		(Shielded Ignition)	
99634	Body—Upper Carburetor .....	4		Includes: No. 290020 Wire—Grnd. 1	
99636	Valve and Seat—Fuel Inlet.....	1		Used on type Nos. 205284, 205310.	
99665	Yoke—Fuel Filter .....	2		No. 290877 Magneto Assembly... 6	
99679	Lever Assembly—Choke .....	2		(Shielded Ignition)	
99686	Sector Assembly—Starter .....	14		Includes: No. 290020 Wire—Grnd. 1	
99700	Shaft and Lever—Choke.....	2		Used on type Nos. 205105, 205161, 205166, 205182, 205183, 205306, 205314.	
	Note: No. 23252 Shaft—Choke.....	1		No. 290878 Magneto Assembly... 6	
	Used on type Nos. 205108, 205125, 205150, 205170, 205177, 205269.			Used on type Nos. 205123, 205189, 205292.	
99714	Filter Assembly—Fuel .....	10		Includes: No. 42215 Connector... 1	
	Note: No. 290093 Filter Assembly—Fuel	10		No. 66104 Insulator... 1	
	Used on type No. 205274.			No. 66205 Wire—Ground 1	
99763	Support Assembly—Foot Lever.....	2		No. 290879 Magneto Assembly... 6	
99764	Support Assembly—Foot Lever.....	2		Used on type No. 205084.	
99793	Tube—Control Casing .....	2		Includes: No. 42215 Connector... 1	
99833	Crank Assembly—Bell .....	2		No. 62598 Baffle..... 1	
99858	Sector Assembly—Starter .....	14		No. 66155 Wire—Ground 1	
99860	Starter Assembly—Foot .....	3 8		290972 Plate—Magneto .....	2
99865	Support Assembly—Foot Lever.....	2 8		Note: No. 290351 Plate—Magneto.....	2
99868	Shaft and Lever—Throttle.....	1		Used on type Nos. 205192, 205303.	
	Note: No. 89736 Shaft and Lever—Throttle .....	1		No. 290869 Plate—Magneto..... 2	
	Used on engines before Serial No. 79294.			Used on type Nos. 205084, 205118, 205120, 205123, 205129, 205134, 205135, 205137, 205150, 205155, 205165, 205168, 205189, 205191, 205269, 205289, 205292, 205295, 205308, 205320.	
99874	Adjuster—Speed .....	1		290918 Lever Assembly—Control .....	3
99876	Carburetor Assembly .....	1		290980 Pin Assembly—Piston (Standard).....	2
	Note: No. 89734 Carburetor Assembly..	1		290981 Pin Assembly—Piston (.005" O.S.).....	2
	Used on engines before Serial No. 79294.			291015 Housing—Starter Clutch .....	10
	No. 89507 Carburetor Assembly..	1		Note: No. 21500 Housing—Clutch Starter	3
	Used on type Nos. 205108, 205125, 205150, 205170, 205177, 205269.			Used on type No. 205177.	
99879	Cover Assembly—Fuel Filter.....	3		No. 21517 Housing—Starter Clutch	3
	Note: No. 290094 Cover Assembly—Fuel	3		Used on type Nos. 205179, 205279.	
	Filter .....	3		291220 Screen—Blower Housing .....	2
	Used on type No. 205274.			Note: No. 291430 Screen—Blower Housing (Full Screen).....	2
99896	Lever—Foot Starter .....	1		Used on engines without starters on magneto side.	
290014	Cover Assembly—Gear Case.....	1 3			
290015	Shaft Assembly—Drive .....	1			
290137	Tank Assembly—Fuel .....	1 13			
290146	Bracket—Fuel Tank Mounting, L.H.....	8			
290147	Bracket—Fuel Tank Mounting, R.H.....	8			
290568	Lever Assembly—Control (Stamped Steel)	4			
	Note: No. 29035 Lever Assembly—Control .....	8			
	Used on type Nos. 205071, 205083, 205104, 205151.				

Before ordering parts, read instructions top page 11



THIS BOOK COVERS TYPE NUMBERS 205000 TO 205499 ONLY

Plate No. 17

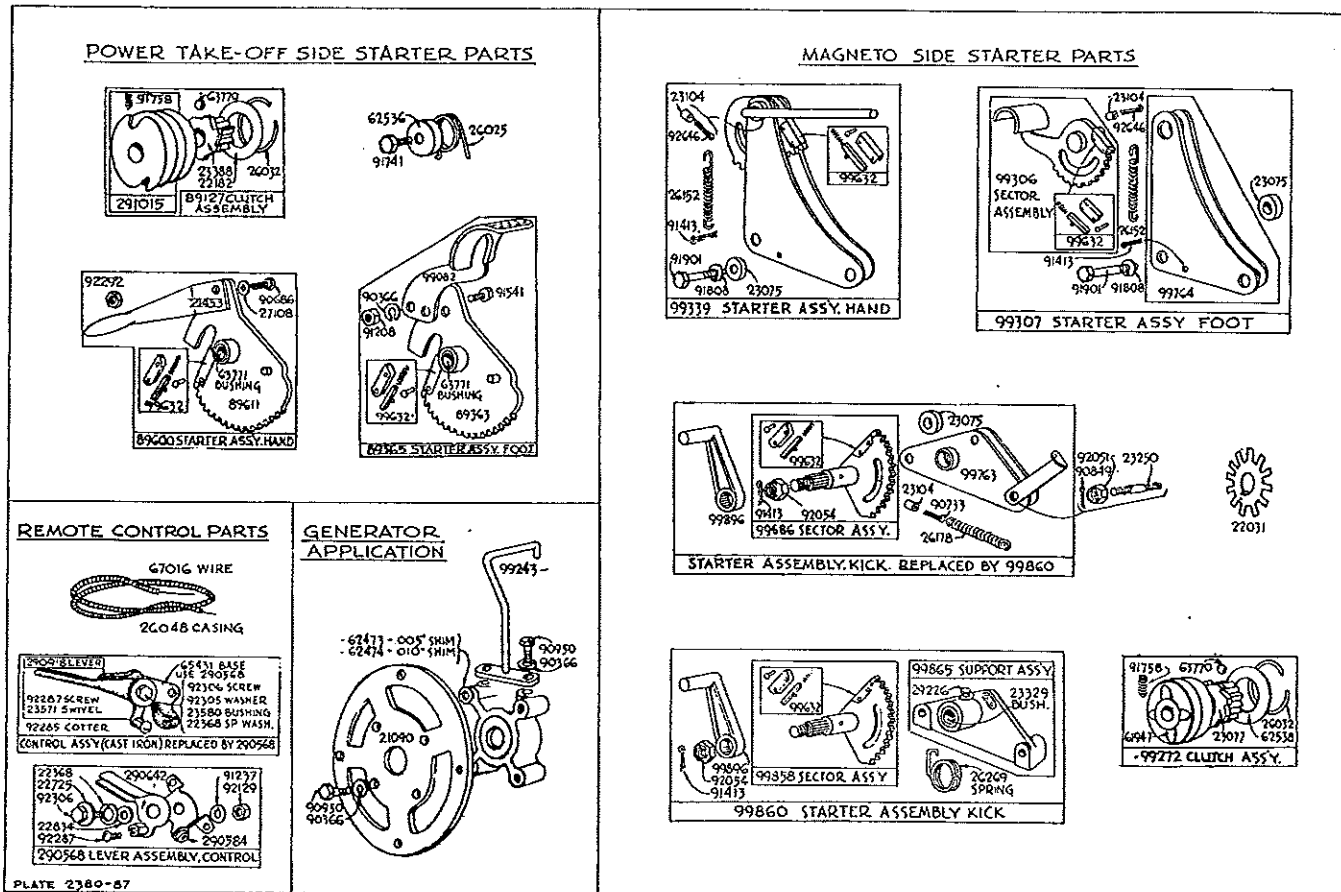

ASSEMBLIES INCLUDE ALL PARTS SHOWN IN BRACKETS ABOVE PARTS LISTED ON PAGE 11 THROUGH 16

**THE GUARANTEE**—For Ninety Days from purchase date, Briggs & Stratton Corporation will replace for the original purchaser, FREE OF CHARGE, any part or parts found, upon examination at our factory at Milwaukee, Wisconsin, or at any Authorized Central Service Distributor's place of business, to be defective under normal use and service, on account of defects in material or workmanship.

All transportation charges on part or parts submitted for replacement under this guarantee must be borne by the purchaser.

**WHAT THIS GUARANTEE DOES NOT INCLUDE**—This guarantee does not cover the free replacement of parts inoperative because of wear occasioned by use. It does not cover the labor cost of replacing parts, neither is it effective if the motor has been the subject of misuse, negligence or accident, nor if it has been repaired or altered outside of our Milwaukee Factory or any Authorized Central Service Distributor in any way which, in our judgment, affects its condition or operation.

# NATION-WIDE SERVICE ORGANIZATION

To provide prompt and efficient service on Briggs & Stratton motors, Authorized Central Service Distributors and Motor Service Stations are located in the principal cities of the United States and Canada.

Each Authorized Service Organization carries a complete stock of original Briggs & Stratton repair parts. Each is equipped with special factory service tools and factory-trained mechanics, assuring expert repair service on all Briggs & Stratton motors.

All Authorized Service Organizations are instructed by the factory to replace free of charge all parts found to be defective in either material or workmanship, according to the conditions of the Briggs & Stratton Guarantee.

All gratis work done under the guarantee is the responsibility of the Authorized Service Organization until all the material involved and supporting facts are submitted to and approved by the factory.

In a difference of opinion regarding a Service Organization's decision, their terms should be accepted and, either through them or direct, have all materials and supporting facts submitted to the factory for review.

Genuine Briggs & Stratton service will assure continuous motor satisfaction. Our long experience in motor maintenance prompts us to urge that all service work be done by an Authorized Service Organization or at our factory. Mechanics unfamiliar with Briggs & Stratton products, or without proper tools, should not be permitted to make major repairs.

Parts and repair work are F. O. B. Factory or any Authorized Briggs & Stratton Central Service Distributor, or Motor Service Station. The Central Service Distributor nearest you (see list below) will be glad to give you the name of our Motor Service Station in your locality. Space does not permit listing here.

## Authorized Central Service Distributors

STATE	CITY	NAME	LOCATION
Alabama	Birmingham 3	Birmingham Electric Battery Co.	Ave. B at 23rd St.
Arizona	Phoenix	Motor Supply Co.	402-414 N. Central Ave.
California	Los Angeles 15	Electric Equipment Co.	1611 S. Hope St.
California	San Francisco 9	Frank Edwards Co., Automotive Service Div.	382-4 Sixth St.
Colorado	Denver 1	Spitzer Electric Co.	43 W. 9th Ave.
Florida	Jacksonville 1	Spencer Electric, Inc.	40 W. Beaver St.
Florida	Miami 42	Electric Equipment Co.	1415 N. W. 21st Terrace
Florida	Tampa 1	Spencer Auto Electric, Inc.	607-11 E. Cass St.
Georgia	Atlanta 3	Auto Electric & Magneto Co.	477 Spring St., N. W.
Illinois	Chicago 16	Mid-States Auto Electric Co.	1905 S. Michigan Ave.
Indiana	Indianapolis 4	Gulling Auto Electric Co.	450 N. Capitol Ave.
Iowa	Des Moines 9	Magneto Carburetor & Electric Co., Inc.	1308 Grand Ave.
Kansas	Wichita 2	The E. S. Cowie Electric Co.	230 S. Topeka Ave.
Kentucky	Lexington 34	Kentucky Ignition Co., Inc.	Rose and Vine Sts.
Kentucky	Louisville 2	Kentucky Ignition Co., Inc.	737 S. 3rd St.
Louisiana	New Orleans 1	A. C. Suhren Co.	4640 S. Carrollton Ave.
Louisiana	Shreveport	Chain Battery & Automotive Supply, Inc.	Spring at Fannin St.
Massachusetts	Boston 64	W. J. Connell Co.	210 Needham St.
Michigan	Detroit 38	Auto Electric & Service Corp.	15550 Woodrow Wilson Ave.
Minnesota	Minneapolis 16	Reinhard Brothers Co., Inc.	4301 Highway 7
Missouri	Kansas City 8	The E. S. Cowie Electric Co.	1819 Wyandotte St.
Missouri	St. Louis 3	Medart Auto Electric Co., Inc.	3134 Washington Blvd.
Montana	Billings	Original Equipment, Inc.	423 N. Broadway
Nebraska	Omaha 2	Carl A. Anderson, Inc.	16th and Jones St.
New Mexico	Albuquerque	Spitzer Electrical Co. of New Mexico	3rd and Mountain Rd.
New York	Buffalo 14	The Battery & Starter Co., Inc.	2505 Main St.
New York	New York 19	The Durham Co., Inc.	806 W. 49th St.
New York	Syracuse 4	F. A. Crossman, Inc.	943 W. Genesee St.
North Carolina	Charlotte 1	Automotive Electric Associates, Inc.	306-14 N. Graham St.
North Dakota	Fargo	Reinhard Bros. Co., Inc.	301 N. Pacific Ave.
Ohio	Cincinnati 2	Gardner, Inc.	1847 Reading Road
Ohio	Cleveland 15	Electric Power & Maintenance Co.	Prospect at E. 30th
Ohio	Toledo 2	Electric Power & Maintenance Co.	26-30 Seventeenth St.
Oklahoma	Oklahoma City 2	American Electric Ignition Co.	124 N. W. 8th St.
Oregon	Portland 9	Tracey & Co., Inc.	N. W. 10th and Glisan
Pennsylvania	Philadelphia 30	Auto Equipment & Service Co., Inc.	1522-24 Fairmount Ave.
Pennsylvania	Pittsburgh 24	Pitt Auto Electric Company	5135 Baum Blvd.
Tennessee	Knoxville 7	R. T. Clapp Company	2016 Magnolia Ave. N. E.
Tennessee	Memphis 4	Automotive Electric Service Co.	982 Linden Ave.
Texas	Amarillo	Beard & Stone Electric Company, Inc.	700 E. 10th St.
Texas	Dallas 1	Beard & Stone Electric Company, Inc.	3909 Live Oak St.
Texas	El Paso	Motor Supply Co.	308 Chihuahua St.
Texas	Houston 1	Beard & Stone Electric Company, Inc.	Milam at Polk Ave.
Texas	San Antonio 6	S. X. Callahan	425 N. Flores St.
Utah	Salt Lake City 13	Frank Edwards Co., Motor Equipment Div.	551 S. State St.
Virginia	Richmond 21	Richmond Battery & Ignition Co.	2912 W. Leigh St.
Washington	Seattle 4	Charles Stewart, Inc.	1741 First Ave. South
Washington	Spokane	Sunset Electric Co.	N. 703 Division St.
Wisconsin	Milwaukee 2	Wisconsin Magneto Co.	918 N. Broadway
<b>DOMINION OF CANADA</b>			
British Columbia	Vancouver	Auto Electric Service (Pacific) Ltd.	1025 Howe St.
Manitoba	Winnipeg	Auto Electric Service (Western) Ltd.	176 Fort St.
Ontario	Toronto 5	Auto Electric Service Company, Limited	1009 Bay St.

See yellow pages of your classified telephone directory for nearby engine service under heading "Engines—Gasoline" or "Gasoline Engines."

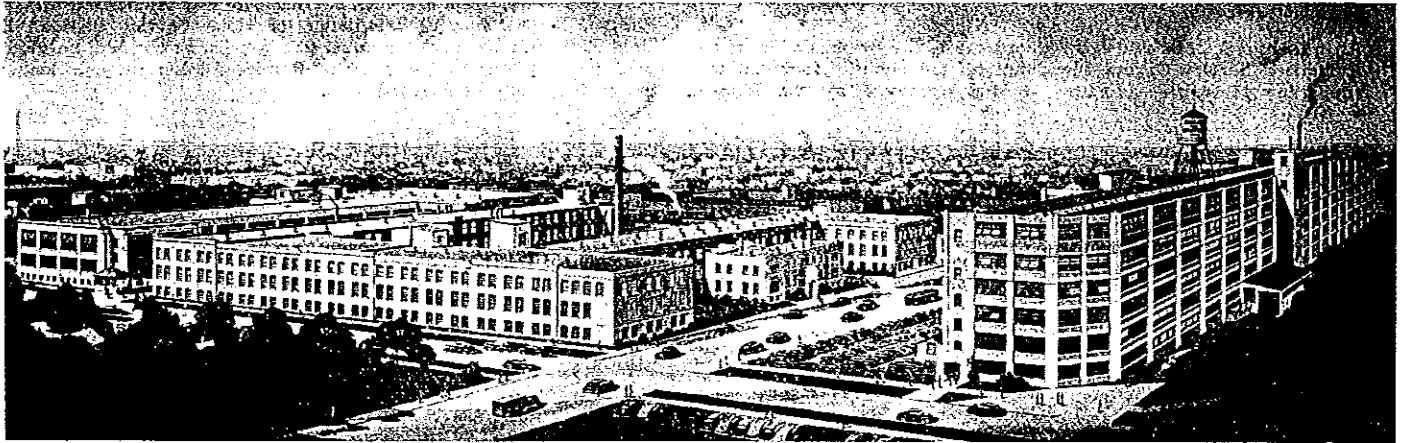

WHERE BRIGGS AND STRATTON MOTORS  
ARE MADE

**T**HESE large and modern factory buildings, located in Milwaukee, Wisconsin, are complete with all modern equipment and machinery for precision construction, economical production, rigid inspection and thorough testing of Briggs & Stratton 4-cycle gasoline motors.

Briggs & Stratton Corp. produces more small 4-cycle air-cooled gasoline motors than any other manufacturer in the world.

**BRIGGS & STRATTON CORP., MILWAUKEE 1, WIS.**