

Operating Instructions

Adjustment and Repair
Information • Parts List

MODELS

"WI"—"WIBP"—"WR"

TYPE NUMBERS FROM 25100 TO 25400 AND 95800 TO 97000

IMPORTANT
ALWAYS USE
GOOD, CLEAN OIL
S. A. E. No. 20

For Temperatures Below 32° F.
Use S. A. E. No. 10W
ADD OIL FREQUENTLY
CHANGE OIL REGULARLY

IMPORTANT
ALWAYS USE
GOOD, CLEAN OIL
S. A. E. No. 20

For Temperatures Below 32° F.
Use S. A. E. No. 10W
ADD OIL FREQUENTLY
CHANGE OIL REGULARLY

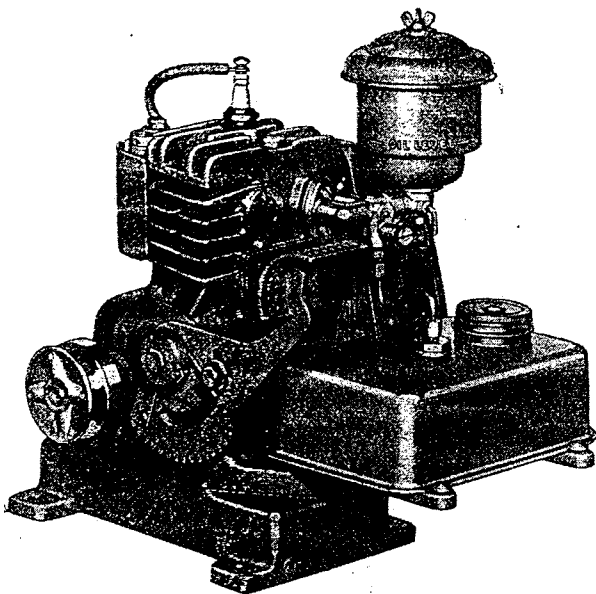

INDEX

	Page
Starting the Motor.....	3
Servicing Reference Chart.....	4
Instructions for Adjustment and Repair.....	4
Repair Parts	10
Parts List, Models "WI," "WIBP," and "WR".....	11 to 16
Illustrated Parts	17-18
Guarantee	17
Nation-Wide Service Organization.....	19
Authorized Central Service Distributors.....	19

Read these instructions carefully before operating this Motor for the first time.

Guessing how to run it may cause you unnecessary inconvenience, aggravation or failure to receive the fine service that is built into it.

There is a right way to operate this Motor. This book tells you how.

Each Motor is carefully tested and adjusted at the factory before packing for shipment, and if correctly operated will perform beyond your expectations.

DO NOT START THIS MOTOR UNTIL YOU HAVE READ CAREFULLY THE "STARTING AND OPERATING INSTRUCTIONS" ON PAGE 3



IMPORTANT SAFETY INFORMATION AND INSTRUCTIONS FOR ENGINE SELECTION ENGINE INSTALLATION ENGINE OPERATION

In the USA and Canada,
our 24 hour hotline is:

18002333723

Briggs & Stratton Corporation
Milwaukee, Wisconsin 53201

www.briggsandstratton.com

Keep these instructions for future reference.



Before installing and operating this engine read and observe all warnings, cautions and instructions on both sides of this sheet, on the engine, and in the operating & maintenance instructions.

NOTE: This sheet of instructions and safety information is not meant to cover all possible conditions and situations that may occur. Read entire Operating & Maintenance Instructions for this engine AND the instructions for the equipment this engine powers. Failure to follow instructions and safety information could result in serious injury or death.

The safety alert symbol () is used to identify safety information about hazards that can result in personal injury.

A signal word (DANGER, WARNING, or CAUTION) is used with the alert symbol to indicate the likelihood and the potential severity of injury. In addition, a hazard symbol may be used to represent the type of hazard.

 **DANGER** indicates a hazard which, if not avoided, will result in death or serious injury.

 **WARNING** indicates a hazard which, if not avoided, could result in death or serious injury.

 **CAUTION** indicates a hazard which, if not avoided, might result in minor or moderate injury.

CAUTION, when used **without** the alert symbol, indicates a situation that **could result in damage to the engine.**

HAZARD SYMBOLS AND MEANINGS



Fire



Explosion



Moving Parts



Toxic Fumes



Hot Surface



Shock



Kickback

(OVER)

FORM MS-6445-01/03

ENGINE SELECTION

 WARNING

Failure to select the correct engine could result in fire or explosion.

- Some engines are unique and designed for specific applications or types of equipment. If this engine will be used to build new equipment, contact Briggs & Stratton to ensure that the engine is appropriate for the intended use.
Note: For all Go-karts use only a model 136200 series engine, which offers improved safety and performance.
- Replacement engines should be the same model as the original engine, or be the Briggs & Stratton designated replacement engine. Refer to the Operation & Maintenance Instructions for engine identification information.
Note: For all Go-karts use only a model 136200 series engine, which offers improved safety and performance.
- Do not use Briggs & Stratton engines on 3-wheel All-Terrain Vehicles (ATVs), motor bikes, air craft products, or vehicles intended for use in competitive events. Briggs & Stratton does not approve of or authorize such uses.

ENGINE INSTALLATION

- [1] Do not attempt to install this engine if you do not have the appropriate tools and knowledge of small engine installation procedures. Use only Briggs & Stratton parts. Contact your Authorized Service Dealer for assistance.
- [2] Do not modify the engine in any way without Briggs & Stratton factory approval. Any such modification is at the owner's sole risk.
- [3] If the exhaust system on the old engine was supplied by the equipment manufacturer, you must transfer the exhaust system and related components (original muffler and related pipes, brackets, clamps, and shields) to the new engine. All components must be in good condition.
- [4]

 WARNING	Install muffler (and muffler deflector if used) so outlet points away from operator, fuel tank, and equipment, and so muffler heat will not damage or deform engine and components.
	
- [5]

 WARNING	Ensure all fuel lines and fittings are properly assembled and do not leak. Replacement parts must be the same model as the original.
	
- [6]

 WARNING	Ensure all wiring, including safety switches and engine shut-off components are completely installed and functioning properly.
	
- [7] Set engine speed to equipment manufacturer's specification. Refer to equipment manufacturer's manual. Do not tamper with governor springs, or other parts that will increase engine speed above specification.

- [8]







 WARNING	All engine parts, including fuel cap, spark plug, muffler, air cleaner, and covers and guards for drive components (gears, belts, shafts, couplings, etc.) must be in place before attempting to start engine.
	
- [9]

 WARNING	If engine is installed on walk behind lawn mower, all mower components, including cutting blade, must be correctly installed before attempting to start engine.
	
- [10]

 WARNING	When working on the engine or equipment, remove spark plug wire from spark plug. For electric start, remove negative wire from battery.
	
- [11]

 WARNING	Do not check for spark with spark plug removed. Use Briggs & Stratton spark tester #19368.
	

ENGINE OPERATION

	 WARNING
	When adding fuel:
<p>Turn engine off and let engine cool at least 2 minutes before removing gas cap.</p> <p>Fill fuel tank outdoors or in well-ventilated area. Fill tank to about 1 inch below lowest portion of neck to allow for fuel expansion.</p> <p>Keep gasoline away from sparks, open flames, pilot lights, heat, and other ignition sources.</p>	
	 WARNING
	When starting engine:
<p>Remove all external equipment/engine loads.</p> <p>Wait until spilled fuel is evaporated. Start engine outdoors.</p> <p>Pull cord slowly until resistance is felt, then pull rapidly.</p> <p>If engine floods, set choke to OPEN/RUN, place throttle in FAST and crank until engine starts.</p>	
	 WARNING
	When operating equipment:
<p>Do not tip engine or equipment at angle which causes gasoline to spill.</p> <p>Run engine outdoors. Do not run in enclosed area, even if doors or windows are open.</p> <p>Do not choke carburetor to stop engine.</p>	

Starting and Operating Instructions

	Paragraph
Before Starting the Motor.....	1
How to Start.....	2
Failure of Motor to Start.....	3

	Paragraph
How to Stop.....	4
General Data	5

1. **BEFORE STARTING THE MOTOR.** Fill the crankcase with MOBILLOIL ARCTIC or any other high grade oil not heavier than **S. A. E. No. 20** for operating motor in temperatures of 32° F. and above. When temperature is **BELOW 32° F.**, use Mobiloil "Arctic Special" or other high grade oil not heavier than **S. A. E. No. 10W.** **HEAVIER OILS MUST NOT BE USED.** Remove blue oil filler plug. Fill oil reservoir by slowly pouring in oil at filler opening. **CAUTION: BE SURE OIL RESERVOIR IS FULL TO POINT OF OVERFLOWING BEFORE REPLACING OIL FILLER CAP.** Crankcase holds 1 pint. Fill air cleaner with oil of the same viscosity as used in the crankcase to the indicated oil level. See paragraph 55. Fill the gas tank with a good grade of clean regular gasoline. Tank holds 1 quart. Do not mix oil and gasoline. See paragraphs 11 to 19.

2. **HOW TO START.** Completely close the choke valve located on air cleaner elbow by turning choke lever clockwise to a horizontal position.

A. Foot Starter Type. Step down quickly on starter pedal to prime and start the motor. After motor starts gradually open the choke valve by moving choke lever counter clockwise or down until motor runs smoothly with choke valve wide open. Operate carburetor choke the same as you operate the choke on your automobile. If you wish to start the motor,

shortly after having stopped it by choking and while it is still warm, step down on starter pedal three or four times without choking. Then if it does not start, prime as explained above. A hot motor does not require as much priming as a cold one. See paragraph 20.

B. Rope Starter Type. Slip the knotted end of the starter rope into the notch of the starter pulley and wind the rope around it. Pull the rope with a quick steady pull to prime and start the motor. See plate No. 1. Operate choke as explained under paragraph 2A.

3. **FAILURE OF MOTOR TO START.** If motor fails to start after a reasonable number of trials do not make any adjustments until you have studied the instructions referred to in the **Servicing Reference Chart**, on page 4.

4. **HOW TO STOP.** To stop models with a suction feed carburetor, as shown in plate No. 4, close choke valve in air cleaner elbow. To stop models with a gravity feed carburetor, as shown in plate No. 4B, press stop switch against spark plug.

5. **GENERAL DATA.** You will find your motor substantially built. It is made of high grade materials by skilled workmen, in a factory fully equipped with the most modern machinery. Before it was shipped, it received many tests and careful inspections.

Plate No. 1

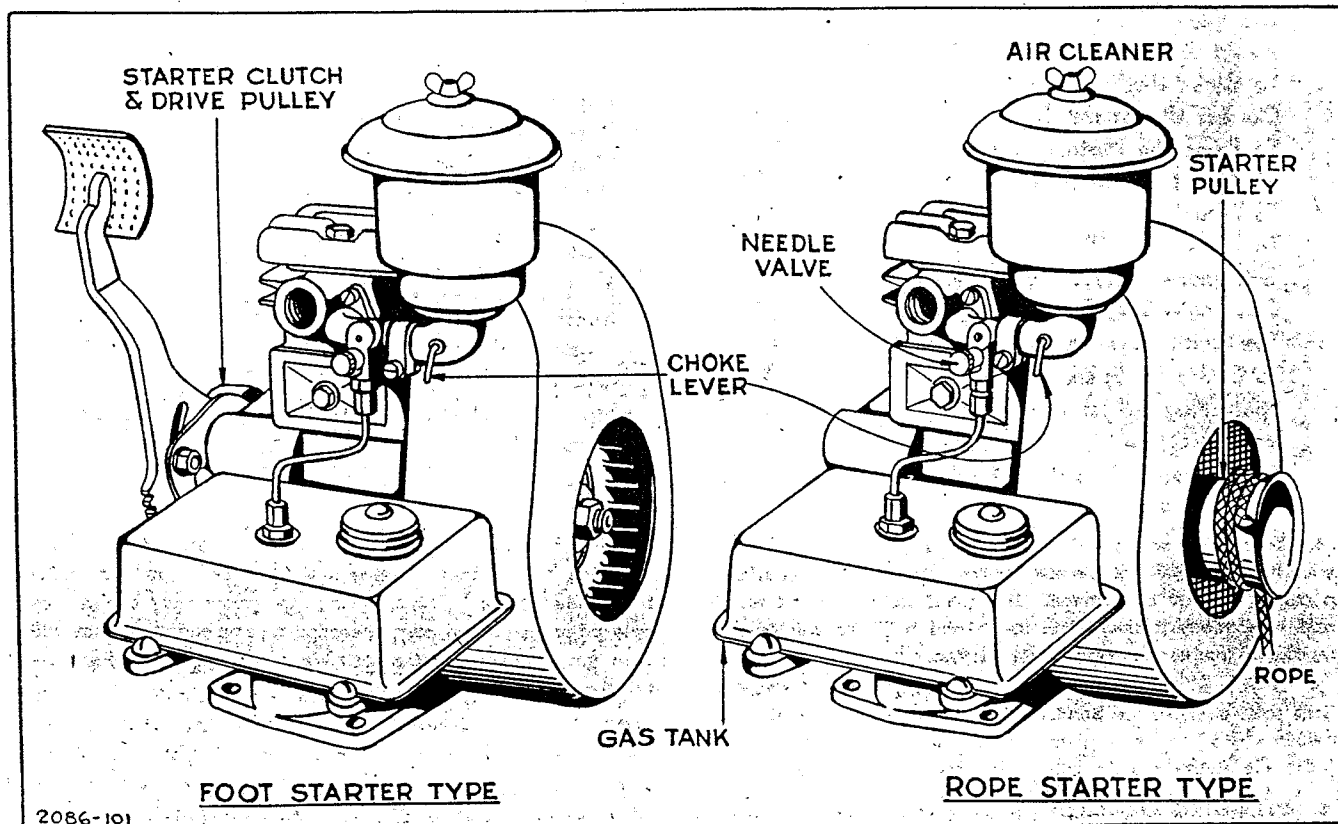

Servicing Reference Chart

	Paragraph
MOTOR FAILS TO START	
Out of Gasoline.....	1-16
Out of Oil.....	1-13-52
Dirt or Gum in Fuel System.....	16 to 19
Incorrect Use of Choke.....	20
Carburetor Out of Adjustment.....	22 to 25
Spark Plug Dirty.....	29-30
Ignition Cable Grounded.....	31
Magneto.....	34 to 40
Poor Compression.....	41 to 49
Starter Clutch.....	60

MOTOR STOPS

Out of Gasoline.....	1-16
Out of Oil.....	1-13-52
Dirt or Gum in Fuel System.....	16 to 19
Motor Overheated.....	13-52-54-58
Motor Overloaded.....	58

MOTOR OVERHEATS

	Paragraph
Out of Oil.....	1-13-52
Oil Needs Changing.....	14-15
Oil Too Heavy.....	12 to 15
Carburetor Out of Adjustment.....	22 to 25
Poor Spark.....	28 to 40
Carbon.....	54
Overloaded.....	58

MOTOR LACKS POWER

Air Cleaner Clogged.....	55
Lack of Oil.....	1-13-52
Add or Change Oil.....	12 to 15
Carburetor Out of Adjustment.....	22 to 25
Motor Not Up to Speed.....	26-27
Poor Spark.....	28 to 40
Poor Compression.....	41 to 49
Carbon.....	54
Muffler Clogged.....	56
Exhaust Tubing.....	57
Overloaded.....	58

Instructions for Adjustment and Repair

	Paragraph
Operating Requirements.....	8
How a 4-Cycle Motor Works.....	10
Keep the Motor Clean.....	11
Use the Right Kind of Oil.....	12
Add Oil Regularly.....	13
Change Oil Frequently.....	14
Use Clean Gasoline.....	16
Avoid Gummy Gasoline.....	17
To Clean the Fuel Lines.....	19
Correct Use of the Choke.....	20
To Prime the Motor.....	21
To Adjust the Carburetor.....	22
To Remove and Replace Carburetor.....	24
To Remove and Replace Carburetor Throttle Governor—Correct Motor Speed.....	25
Governor—Speed Adjustment.....	26
The Ignition System.....	27
To Check for Spark.....	28
Spark Plug Adjustment.....	29
Ignition Cable.....	30
To Remove and Replace Flywheel.....	31
	32

	Paragraph
To Remove and Replace Magneto Assembly.....	34
Magneto Timing.....	35
To Adjust and Clean Contact Points.....	36
To Replace Condenser.....	37
To Replace and Adjust Armature.....	39
Cylinder Head.....	41
Compression.....	42
Valve Adjustment.....	43
Piston.....	47
Piston Rings.....	49
Piston Pin.....	50
Connecting Rod.....	51
Oil Pump.....	52
Oil Leaks.....	53
Carbon.....	54
Air Cleaner.....	55
Muffler.....	56
Exhaust Tubing.....	57
Overload.....	58
Starter Pedal Adjustment.....	59
Starter Clutch.....	60
Parts.....	61

6. Your motor will give you better service if you do not tinker with it. This does not mean, however, that it does not require a certain amount of attention. Give it the right kind of fuel, oil, and care. Keep it clean both inside and out. You will be well repaid in trouble-free, satisfactory service.

7. If you should experience any difficulty, follow the instructions referred to in the **Servicing Reference Chart** above. If you cannot easily remedy it, consult your dealer or a nearby Briggs & Stratton Authorized Central Service Distributor, see page 19.

8. **OPERATING REQUIREMENTS.** A gasoline motor to operate properly must have all parts in correct adjustment to provide

good ignition, carburetion, compression and cooling. And of equal importance, the oil and gasoline used must be clean and of the recommended grades. The following instructions fully explain the simple adjustments and offer operating recommendations that will assure you complete satisfaction. We urge you to carefully observe them.

9. The reliability, economy, and ease of starting which characterize this motor are due in part to the fact that it is of the 4-stroke cycle design commonly called "4-cycle," the same design used in all automotive motors. As the name indicates there are four strokes to one complete power cycle.

10. **HOW A 4-CYCLE MOTOR OPERATES.** On the **intake stroke** the piston goes down, producing a vacuum in the cylinder, thereby drawing fuel up through the carburetor so that the space above the piston becomes filled with combustible gas. During this stroke the intake valve is open. Next the piston comes up on the **compression stroke** with both valves closed. At the top of the compression stroke a spark occurs at the spark plug, firing the highly compressed gas. This produces an explosion above the piston which forces it down on the **power stroke**. Both valves are closed. On the next upstroke of the piston, called the **exhaust stroke**, the exhaust valve is open, and the burned gases driven out. See plate No. 2.

The 4-Stroke Cycle
Plate No. 2

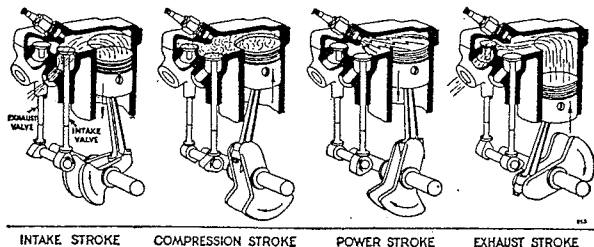

11. **KEEP THE MOTOR CLEAN.** It will pay you to keep your motor clean both inside and outside. See that no dirt or water enters motor when filling with oil or gasoline. As a precautionary measure always wipe off the gasoline cap and oil filler plug, as well as around them before refilling. Dirt in the motor or gasoline tank will cause trouble and even serious damage. Also be sure to remove any dirt or grass that may accumulate in flywheel housing or between cylinder fins.

12. **USE THE RIGHT KIND OF OIL.** Correct lubrication is important. We recommend the use of MOBIL OIL "ARCTIC" S. A. E. No. 20 for operating this motor in temperatures of 32° F. and above. When temperature is BELOW 32° F., use Mobil Oil "Arctic Special" S. A. E. No. 10W. Other high grade oil may be used providing it has similar characteristics and body. A heavier oil which might be satisfactory in a tractor or for lubricating farm machinery must NOT be used. Do not mix oil with the gasoline. This 4-cycle motor is provided with an independent efficient pump lubrication system. There are no external parts which require separate oiling.

13. **ADD OIL REGULARLY.** A motor which is run without oil will be ruined within a few minutes. To avoid the possibility of such an occurrence and the resulting expense, always fill the oil reservoir at the blue plug to the top of the filler plug opening after each five hours of motor operation. Capacity of oil reservoir is 1 pint.

14. **CHANGE OIL FREQUENTLY.** After every twenty-five hours of motor operation, the oil should be completely drained from the crankcase. Do not remove motor from its mounting base. Remove the drain plug located in either end of base. We do not recommend flushing out with kerosene. Replace the drain plug, refill with fresh oil and replace the blue filler plug.

15. In the normal running of any motor, small particles of metal from the cylinder walls, pistons and bearings will gradually work into the oil. Dust particles from the air also get into the oil. Sludge, a gummy mass, forms which clogs up the oil passages. If the oil is not changed regularly, these foreign particles cause increased friction and a grinding action which shortens the life of the motor. Fresh oil also assists in cooling, for old oil gradually becomes thick and loses its cooling as well as its lubricating qualities.

16. **USE CLEAN GASOLINE.** A good grade of clean, fresh, regular gasoline is recommended. Too high test gasoline may form vapor-lock in gas line when motor gets hot. This interrupts the

flow of gasoline and causes motor to stop. Be sure that the small vent hole in the gasoline tank cap is not clogged up, for air must enter the tank to allow the gasoline to flow to the carburetor. Test by blowing through top of cap.

17. **AVOID GUMMY GASOLINE.** If you experience trouble with a gummy, sticky substance with a peculiar sharp obnoxious smell, change to another grade of gasoline. This gum comes from the gasoline and clogs carburetor, gas line, gasoline tank, check valve, etc. You can check your gasoline by evaporating a half pint in an open dish. If a quantity of gum remains, try another kind that is clean and fresh.

18. You can avoid most trouble from gum if you will keep the tank full when you are not using the motor. If you use it only occasionally, drain tank completely and refill when motor is used again. The reason for this is that evaporation of stale gasoline causes most gum deposits.

19. **TO CLEAN THE FUEL LINES.** Disconnect the gasoline line at the carburetor and also at the gas tank. Blow through the gas line to clear on models with suction feed carburetors. Remove the gas tank feed pipe which is screwed into the gas tank proper. At its base you will find a screen which may be clogged. To determine whether this pipe itself is clear, blow through the pipe from the screen end. There is a check ball in the base of this pipe which must be free. See plate No. 3. Check ball must close air passage when blowing through opposite end of pipe. When replacing gas pipe in tank, be sure to place gasket between gas tank and gas pipe nut. On models with gravity feed carburetors, clean out the gasoline filter bowl and screen. Also see that gasket is not torn. IMPORTANT: If you find a gummy varnish-like substance, alcohol or acetone will dissolve it. See paragraphs 17 and 18.

Gas Pipe
Plate No. 3

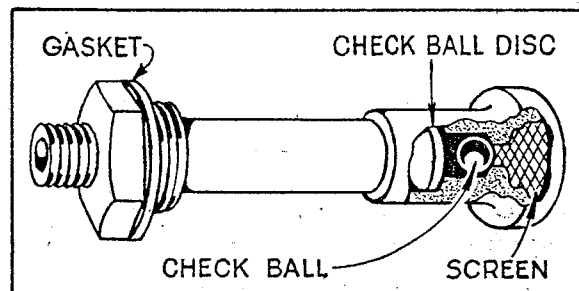

20. **CORRECT USE OF THE CHOKE.** The correct carburetor setting (see paragraph 23) gives the motor the best mixture to run on when it is hot. For starting, it is necessary to choke the carburetor to get a rich mixture, because cold gasoline does not vaporize readily. A warm or hot motor requires very little choking. Until you become familiar with your motor, however, you may make the mistake of not choking the carburetor enough or you may choke it too much. If motor fails to start after cranking three or four times with the choke up, or closed, try cranking two or three times with the choke partly closed and then all the way open. Use motor choke the same as you use an automobile choke.

21. **TO PRIME THE MOTOR.** The motor may fail to start for the reason that either the carburetor is incorrectly adjusted or dirty, or the fuel line or gas pipe check valve in the gasoline tank is dirty or clogged, or you are out of gasoline. To determine the cause, prime the motor by removing the spark plug and pour a half teaspoonful of gasoline into the spark plug opening. Replace the spark plug and crank the motor. If it fires for three or four revolutions and stops, the difficulty is definitely in the fuel system. See paragraphs 19, 22 to 25. If motor will not fire at all, check the ignition system, see paragraphs 28 to 40; also compression, paragraphs 42 to 49.

22. TO ADJUST THE CARBURETOR. The carburetor shown in plate No. 4 is a suction type feed and that in plate No. 4-B is a gravity type feed. The gasoline supply with both types of carburetors is regulated by a needle valve. At any set speed the throttle is automatically controlled by the governor. For speed adjustments see paragraphs 26 and 27 A and B.

23. To adjust the carburetor, completely close needle valve by turning to right or clock-wise as far as possible. Do not screw up too tight or use force when closing needle valve, or the seat, or taper of needle valve may be damaged. From closed position, open needle valve one complete turn. After the motor has been started and warmed up with the choke wide open, make final adjustment by turning the needle valve to the point at which motor operates most smoothly with full load. This setting will also take care of starting with use of the choke. When starting cold motor, if it is necessary to keep choke partially closed several minutes before motor runs smoothly, carburetor setting is too lean and needle valve should be opened a notch or two—turn to left. If the carburetor throttle on motors with the suction type

feed acts sluggish or motor does not govern smoothly, it is usually caused by a dirty or gummy throttle. See paragraph 25. For governor adjustments see paragraph 27 A and B.

24. A. TO REMOVE AND REPLACE CARBURETOR. To remove suction feed carburetor disconnect gasoline line from carburetor. Remove blower case. Remove valve cover plate. Loosen two carburetor mounting screws. Carefully remove carburetor and, without stretching governor spring, unhook its lower end. Do not remove governor spring or link from throttle lever. Then unhook carburetor from the throttle link. To remove gravity feed carburetor, close shut-off valve at gas filter and disconnect gasoline line. Remove blower housing with tank attached. Remove air cleaner from carburetor. Unhook governor spring at lower end. Remove two carburetor mounting screws. Hold carburetor in left hand and with right hand bring governor link toward you. Tip carburetor up slightly and unhook governor link from throttle lever. Do not remove governor spring link from throttle lever. To replace, reverse the operations as performed above.

CAUTION: Be sure to replace the carburetor gasket. In replacing the throttle link be sure that the upper or hooked end is away from the carburetor. See plate Nos. 4 and 4-B. The throttle link must operate freely in the governor arm blade and carburetor throttle lever.

B. Manual Speed Control. Unhook manual speed control spring from carburetor body. See plate No. 4-A. All other operations same as paragraph 24-A.

25. TO REMOVE AND REPLACE CARBURETOR THROTTLE. To clean the carburetor throttle in suction feed type, remove the carburetor as explained in the previous paragraph. Then remove throttle cotter pin and washer and slip throttle from body. Clean in alcohol or acetone. Do not scrape.

Carburetor and Governor Hook-up
Fixed Speed Control Plate No. 4 Manual Speed Control Plate No. 4-A

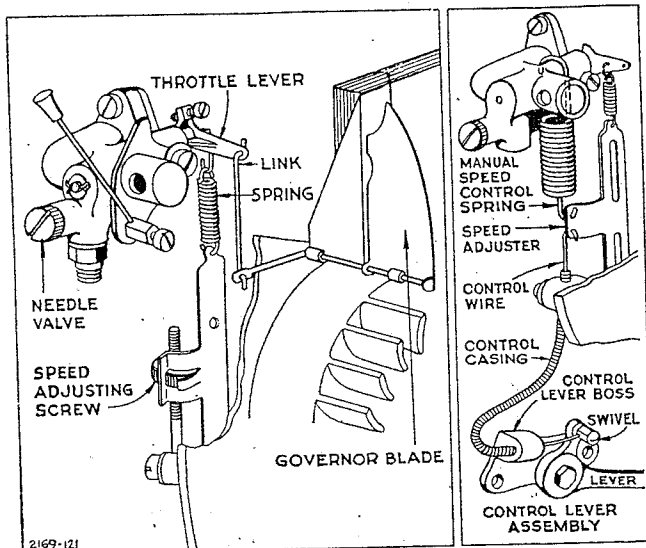

Carburetor Throttle Plate No. 5

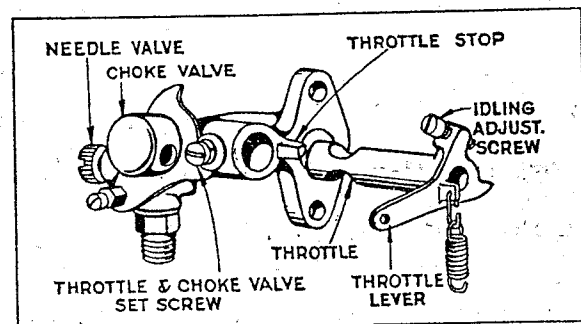

Gravity Type Carburetor Plate No. 4-B

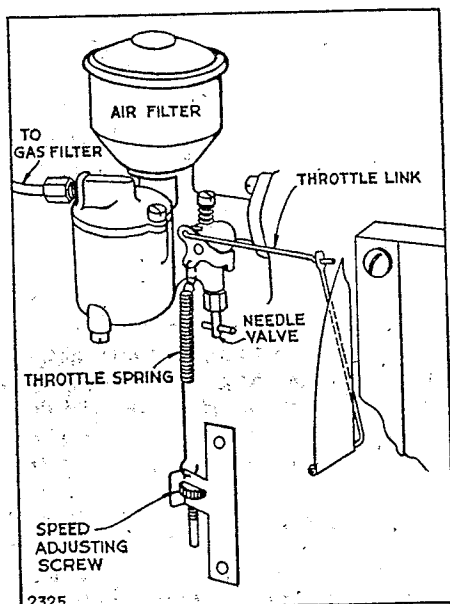

26. GOVERNOR—CORRECT MOTOR SPEED. The speed of your motor at any set speed is automatically maintained under varying loads by a pneumatic governor. It is operated by the air current blown by the flywheel. The governor was carefully adjusted at the factory to maintain normal speed under load. Do not re-adjust unless absolutely necessary. Recommended speed is from 2500 to 2900 R.P.M.

27. GOVERNOR SPEED ADJUSTMENT.

A. Fixed Speed Control. A speed adjuster is located beneath carburetor on magneto plate. To increase motor speed, turn speed adjusting nut counter clockwise. To decrease speed, turn speed adjusting nut clockwise. See plate No. 4. To remove governor parts, see paragraph 24-A.

B. Manual Speed Control. To increase motor speed pull lever so that swivel moves away from control lever boss. To decrease speed push lever so that swivel moves toward control lever boss. See plate No. 4-A. To remove or replace governor parts, see paragraph 24-B.

28. THE IGNITION SYSTEM. The spark is produced by a high tension magneto consisting of armature, condenser, contact points and rotating magnets cast in the flywheel. This is a simple self-contained system which is very reliable. It also does away with batteries. The ignition current is sent into the motor cylinder through the ignition cable and spark plug. The magneto itself as well as the cable and spark plug must all be in proper condition and adjustment to insure a good hot spark.

29. TO CHECK FOR SPARK. To prove that a satisfactory spark is being delivered by the magneto, remove the ignition cable from the plug. Hold ignition cable terminal about $\frac{1}{8}$ " from any metal part of the cylinder head (keep hand on insulated part of the cable to avoid a shock). Turn motor with starter, and if the spark jumps this gap the entire ignition system, with the exception of the spark plug, is O.K. See plate No. 6. To check spark plug see paragraph 30.) If no spark, check cable, see paragraph 31, and refer to magneto adjustments paragraphs 32 to 40.

Checking Spark
Plate No. 6

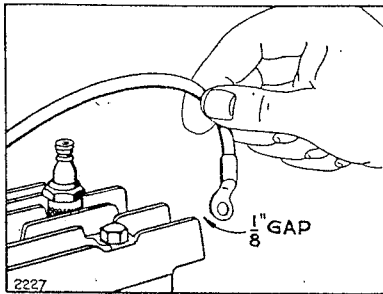

Spark Plug
Plate No. 7

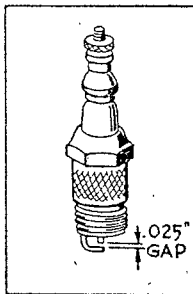

30. SPARK PLUG ADJUSTMENT. Spark plugs should be cleaned and points reset to .025" after each 100 hours of operation. See plate No. 7. Points burn away in service. The porcelain is to prevent the spark from jumping anywhere except at the gap, and if cracked or broken it will prevent the plug firing. Water on the outside of the spark plug may permit the high voltage current to leak over the surface of the porcelain. Dirt or carbon on it will do the same thing. The spark plug can be cleaned by washing off the carbon with gasoline or kitchen scouring powder. Points should be scraped or sandpapered. See plate No. 7. Always keep a new plug on hand. We recommend the use of Champion J8 or its exact equivalent.

When reassembling spark plug to cylinder head put a little graphite grease on threads. Do not get grease on points.

31. IGNITION CABLE. Insulation must not be broken or soaked with oil or water or grounded in any way where it touches the motor, or it will interfere with good ignition. To check cable all the way to magneto it is necessary to remove blower case. Ignition cable should be securely wound to the secondary terminal loop of the coil. See plate No. 11.

32. TO REMOVE AND REPLACE FLYWHEEL. The flywheel is securely mounted to the crankshaft by means of a taper fit, a key and a left-hand nut and spring washer.

A. Rope Starter Motors. Remove the blower housing. Bolt or clamp motor to work bench. Place a wood block under flywheel fin on right side of flywheel or a small rod between fins to hold it rigid and prevent turning as you loosen nut. See plate No. 8. Use large wrench, 10 inch or bigger. To start nut to the RIGHT, tap end of wrench handle lightly with hammer. Tap carefully or a broken fin may result, which will throw flywheel out of balance. After nut is removed, loosen flywheel by placing the wood block against end of crankshaft and striking with a hammer. Pull off flywheel.

B. Hand Lever and Foot Starter Motors. On models with starter on blower housing side of motor, remove starter assembly, loosen set screw and slip clutch housing from shaft, remove blower housing and proceed to remove flywheel as in "A." See plate No. 8.

33. To reassemble, locate flywheel on crankshaft with key and install spring washer with the hollow or concave side next to the flywheel. Turn nut to LEFT until tight. Then use block under fin on left side of flywheel or rod between fins to hold flywheel rigid and draw nut up very tight by tapping wrench handle with hammer.

34. TO REMOVE AND REPLACE MAGNETO ASSEMBLY. After removing the flywheel as explained in paragraph 32, remove contact point dust cover held in place by two mounting screws.

Removing Flywheel
Plate No. 8

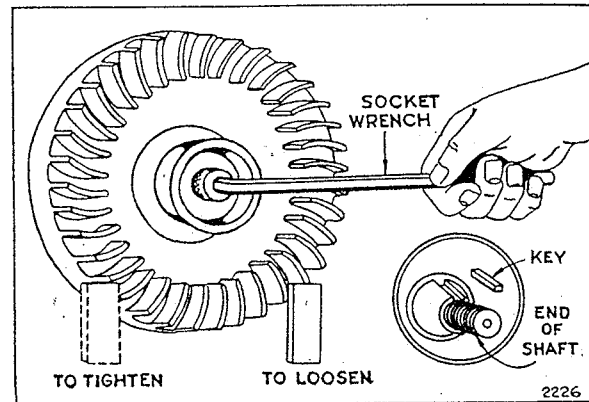

Remove valve cover plate, remove carburetor, see paragraph 24 A and B. Unhook governor spring, detach the ignition cable from spark plug and unscrew the four magneto plate mounting screws. To replace, use same gasket between the plate and crankcase, or if damaged, a new gasket, see part numbers 67307, 67597, 67607 of proper thickness to get correct end play of .002" to .008" between magneto bearing and crankshaft thrust faces, as shown in plate No. 9. Use lockwashers under mounting screws.

35. MAGNETO TIMING. Magneto assembly is always correctly timed with the motor when the flywheel is assembled to the tapered crankshaft with a key and securely held in place with LEFT hand threaded nut. Do not attempt to change the timing by relocating any parts or filing crankshaft timing flat. Always use soft key part No. 61760—if steel key is used and flywheel becomes loose, it will damage the keyway in the crankshaft.

Correct End Play
Plate No. 9

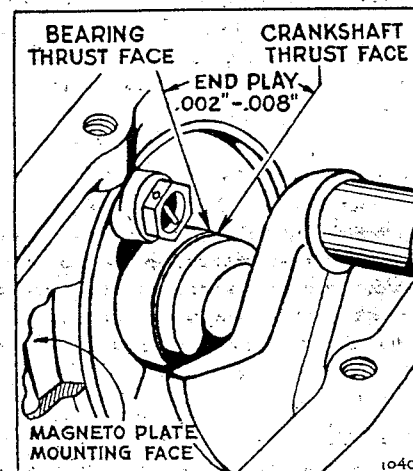

36. **TO ADJUST AND CLEAN CONTACT POINTS.** Remove blower housing and flywheel. Turn crankshaft by hand to see if contact points open and close properly. Points must be clean and line up squarely to make good electrical contact. Do not use a steel file on contact points — use a carborundum contact point file. Adjust gap to .020" by loosening the adjusting lock screw and moving contact point bracket up or down. When proper gap is obtained tighten lock screw securely. If either or both points become badly pitted or burned and need replacement, always order complete assembly Part No. 29667.

Contact Points and Condenser
Plate No. 10

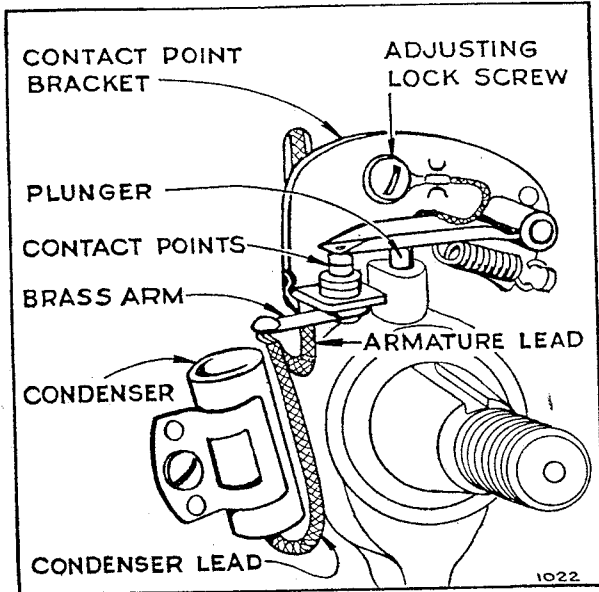

37. **TO REPLACE CONDENSER.** A leaky or weak condenser may cause the motor to start hard, to sputter or misfire under load. If motor misfires after checking gasoline line, carburetor, spark plug, cable and contact points, install a new condenser. Both the condenser lead and armature lead must be soldered to brass arm, see plate No. 10. Be sure to push condenser lead down between condenser and hub of magneto plate so it cannot rub against flywheel.

38. If after new condenser has been installed the ignition system still does not deliver a satisfactory spark, we recommend sending the complete magneto unit including flywheel to the nearest Briggs & Stratton Service Distributor for proper adjustment.

39. **TO REPLACE AND ADJUST ARMATURE.** Remove primary armature lead wire of coil from brass arm on contact bracket. Remove high tension ignition cable from secondary terminal loop in coil. Unscrew four armature mounting screws. After installing new armature be sure that condenser lead wire and armature lead wire from coil are soldered to brass arm on contact bracket. See plates Nos. 10 and 11. Replace mounting screws, inserting loop of ground wire under screw and draw screws up tight.

40. Air gap of .008" to .012" must be maintained between armature core ends and flywheel. Gap must only be sufficient to prevent rubbing, but not over .012", or poor ignition will result. To adjust gap to proper clearance, loosen the four armature mounting screws, slide armature assembly up and place correct feeler gauges or 3 thicknesses of newspaper between rim of flywheel and armature core ends. Lower armature assembly until core ends rest on gauge or paper and tighten mounting screws securely. See plate No. 11.

41. **CYLINDER HEAD.** The cylinder head is held on with six cap screws. When the cylinder head has been removed for the

purpose of cleaning carbon or grinding valves, care should be used in replacing it. Use a new gasket if possible. Otherwise clean the old one and coat both sides with cup grease. We do not recommend the use of shellac on cylinder head gaskets. Tighten each cap screw a little at a time so that the cylinder head is pulled down evenly. Screws need be only moderately tight.

Complete Magneto Assembly
Plate No. 11

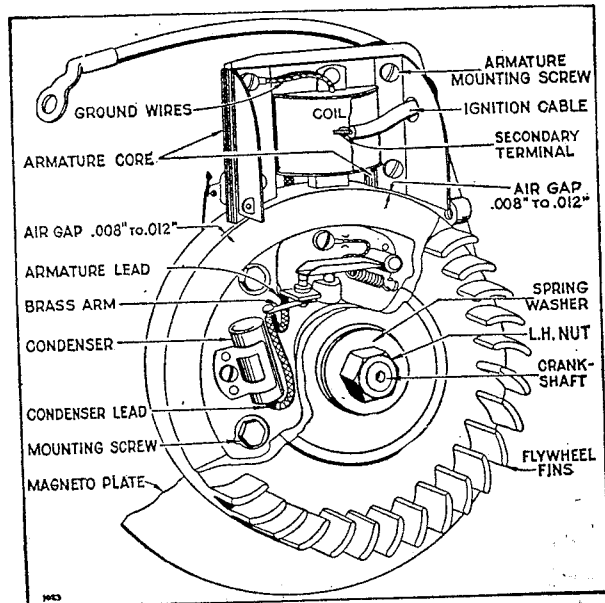

42. **COMPRESSION.** Proper compression is obtained when valves seat properly, gaskets do not leak and piston and rings are properly fitted. When tuning up a motor, it is always well to check compression. This is done by turning the motor over slowly. If a point of resistance is offered every other revolution, compression should be satisfactory. If motor turns over without compression resistance for a full cycle, a worn piston, piston rings, cylinder wall, or leaky valves or leaky gaskets are present. See that spark plug has a gasket under it and is drawn up tight. Also check cylinder head gasket and tighten cylinder head bolts.

43. **VALVE ADJUSTMENT.** To check valve clearance remove valve cover plate on cylinder below carburetor. The correct clearance on the exhaust valve is .014" to .016" and on the intake valve .005" to .007" when the motor is cold. Tappet clearance is adjusted by grinding required amount from the end of valve stem. End of stem must be square with the stem proper.

44. To remove the valves, remove cylinder head and, if not dismantled, drain oil from crankcase. Invert cylinder. Compress the

Valve Timing — Plate No. 12

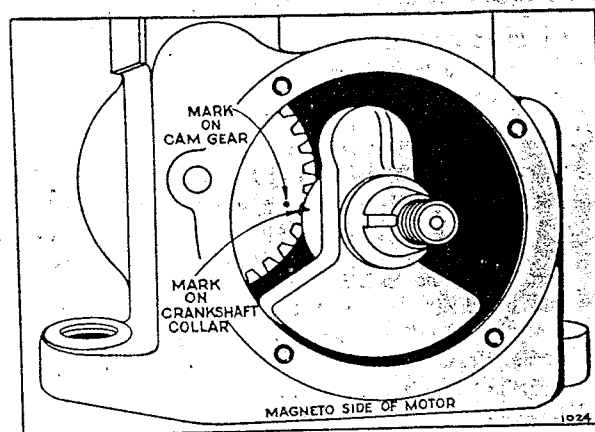

valve spring with a screw driver and pull out valve retainer pin with long nose pliers. Tilt cylinder back far enough to allow valve to drop, permitting its stem to clear the spring. Pry the spring out with screw driver. To replace, reverse the operations as performed above.

45. To reseat valves, grind in same manner as automobile valves. If valves stick they may be coated with gum or carbon. To remove gum use alcohol or acetone. Clean valve stems thoroughly with wire brush or emery cloth. Also scrape all carbon from valve ports.

46. The timing of the valves is taken care of by the meshing of the cam gear with the gear on the crankshaft. These gears are properly meshed when the mark on the cam shaft gear is in line with the mark on the crankshaft collar.

47. **PISTON.** The piston in this motor is made of a special aluminum alloy which is very light in weight. The clearance between the piston and cylinder wall is .005" to .0065". The top and second lands of the piston are smaller than the skirt to allow for greater expansion at the piston head. This clearance is to compensate for the expansion of aluminum when hot. When piston is removed be sure to clean carbon from head of piston and ring grooves. If piston is out of round or scored it should be replaced.

48. When fitting a new piston in the motor, assemble it with the free side pin hole (indicated with an "X" on boss) toward the magneto side. If an oversize piston is necessary, we recommend that reboring be done by an Authorized Central Service Distributor listed on page 19.

49. **PISTON RINGS.** The piston rings when fitted in the cylinder should have a gap from .007" to .017". The rings should be fitted in the cylinder below the piston ring travel. Before assembling new rings to piston be sure that piston ring grooves are thoroughly cleaned, and rings fit free in the grooves.

50. **PISTON PIN.** The piston pin is a free fit on one side of the piston and a tight fit in the other. To remove this pin without special equipment it is advisable to heat the piston in boiling water which causes the aluminum to expand. Cut a wooden pin a little smaller than the size of the piston pin and use this and a hammer to drive the pin out. Drive the pin out through the free fit hole. This hole is toward the magneto side and is indicated with an "X" on the pin hole boss. You should, of course, drive the pin out while the piston is still hot. To easily replace the pin, the piston should be heated. In later model motors the piston pin is a slip fit in the piston. To remove it from the piston first remove the lock rings, then slip pin out of piston.

51. **CONNECTING ROD.** The connecting rod is also made of a special aluminum alloy which combines strength with light weight. When assembling connecting rod to crankshaft, the as-

Connecting Rod — Plate No. 13

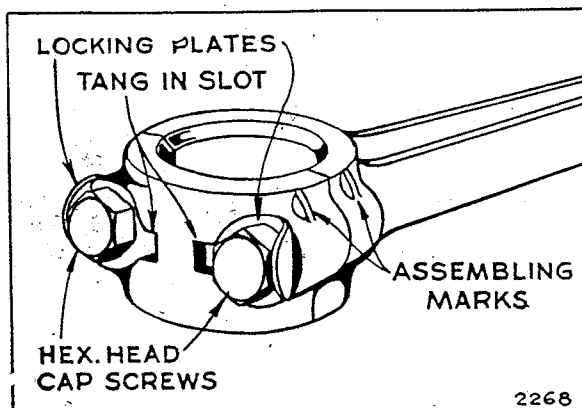

sembly marks on the lower bearing must be toward the magneto side. The assembly marks on cap and rod must be on the same side. On motors after serial No. 108719, place locking plate tang in slot and bend locking plates against hexagon head. See plate No. 13.

52. **OIL PUMP.** The oil pump is assembled to the base. An inoperative pump will result in insufficient lubrication which may score the cylinder and piston assembly. To check oil pump, remove from base. Place pump in a pan of oil about 1/2" deep. Work plunger up and down. If oil is sprayed out, oil pump is in good working condition. If clogged, submerge complete unit in gasoline or kerosene for three or four hours to loosen accumulated sludge or gum. If still inoperative it should be replaced. In assembling, be sure that spring and plunger are in place.

Oil Pump — Plate No. 14

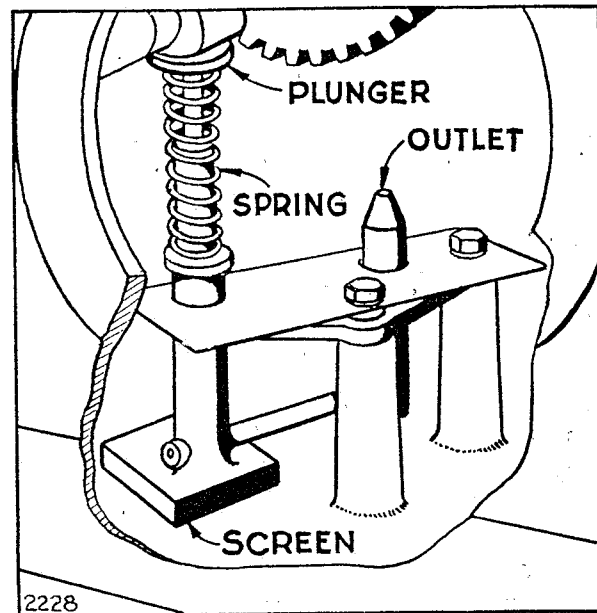

53. **OIL LEAKS.** If oil leaks from either end of crankshaft, remove base plate from motor. Oil return valves are screwed into crank case and magneto back plate at base of main bearings. Remove oil return valve and clean or flush with gasoline and blow out any dirt lodged under the small disc. See plate No. 9.

54. **CARBON.** Excessive carbon is caused by improper grade of oil — too much oil, usually the result of piston rings not seating properly or sticking — carburetor set too rich — or long service. An unusual amount of carbon is noticeable by motor knocking or loss of power. Occasionally remove carbon from piston head, cylinder head and top of cylinder bore.

55. **AIR CLEANER.** The air cleaner is to protect the motor from dust and dirt. No motor can stand up under the grinding action that takes place when dust and dirt particles are drawn into the motor through the carburetor. Air cleaners should be cleaned occasionally as follows:

OIL BATH TYPE. Wash the outside of the filter element with a rag or brush dipped in gasoline or kerosene. Do not submerge. Then clean the bowl by submerging it in gasoline or kerosene. Fill cleaner with oil of the same viscosity as used in the crankcase up to the level marked on cleaner. See Instructions on air cleaner label.

MOSS TYPE. To clean this type of air cleaner, remove it from carburetor. Remove moss from cleaner and wash in gasoline or kerosene.

58. MUFFLER. After long periods of service it is possible that the muffler will become clogged to the point where it will affect the motor's power. To check the muffler unscrew it from the motor and run water into the open end of the muffler. If full streams of water come out of the small holes at the end of the muffler, you will know that it is not clogged up. If the water runs through very slowly, however, the muffler is probably clogged and should be replaced.

57. EXHAUST TUBING. A certain amount of water forms inside of the exhaust tube after it cools off due to condensation. After motor is stopped, place exhaust tube so that water from condensation cannot drain into exhaust port of motor to corrode the mechanical parts and eventually result in trouble. If exhaust pipe is too long, or clogged, back pressure will reduce motor power.

58. OVERLOAD. Always be sure that the machine the motor is operating is well lubricated and running freely. If it is not, it may cause the motor to become overloaded, resulting in it overheating, losing power, or even stopping entirely.

59. STARTER PEDAL ADJUSTMENT. The starter pedal is made in two parts, the pedal proper and pedal stop, held together with the adjusting bolt. To adjust, loosen the bolt and set pedal to desired position. Adjust the pedal to get the longest possible stroke without striking any part of the machine. The first tooth on the starter sector must clear the teeth of the starter pinion. Should the starter pedal return spring loosen or lose its tension, loosen the bolt which holds the return spring cup. Turn the cup to the left until there is just enough tension to return the starter pedal back to the normal position after depressing it, and tighten

Starter Pedal Adjustment
Plate No. 15

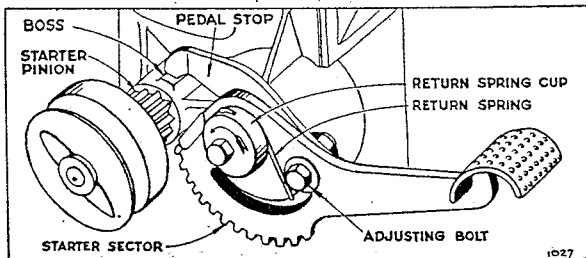

the bolt. Too much tension may cause spring to break. Be sure the spring is in the proper position with the long end below the pedal adjusting bolt and the hooked end in the slot of the cup.

60. STARTER CLUTCH. If the starter clutch slips or fails to turn the motor, when stepping on the starter pedal, it is probably caused by one of the following reasons: Loose set screw. Worn clutch housing. Worn or broken pinion.

First tighten the set screw to be sure clutch is tight on the crankshaft. Use $\frac{1}{8}$ " Allen hexagon set-screw wrench. If the clutch still slips, loosen set screw and remove clutch from the shaft. Pry out the snap spring with a sharp tool, holding the clutch in the position shown in plate No. 16, as a caution against the spring jumping out. Check the parts carefully for wear or damage and replace those necessary. To reassemble, replace the parts in the same order, and slip the spring back in place. Replace pulley clutch on shaft with the set screw hole lined up with recess in crankshaft extension. Securely tighten set screw.

Starter Clutch
Plate No. 16

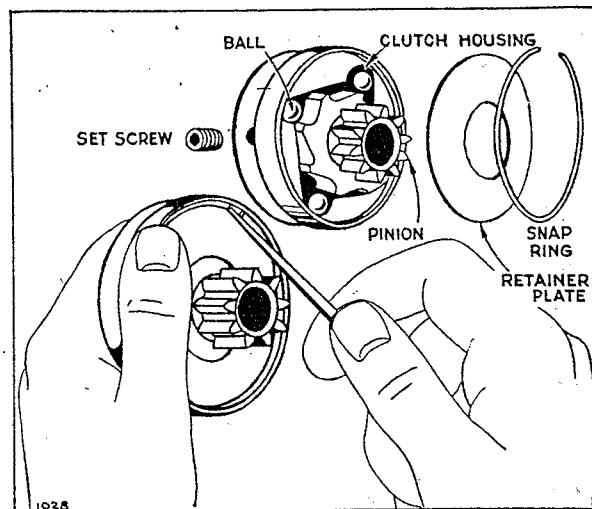

61. PARTS. All parts should be ordered from your dealer or nearest Briggs & Stratton Service Distributor, listed on page 19.

Repair Parts

Paragraph
Always Give Type, Model and Serial Number 63
How to Make Out Parts Order..... 65
Prices 69

Page
Parts List 11 to 16
Parts Illustrations 17-18

62. To assure continued satisfactory performance, do not attempt to use substitute repair parts when overhauling or repairing the Briggs & Stratton Motor. Insist that all repair parts be original Briggs & Stratton parts.

63. ALWAYS GIVE TYPE, MODEL AND SERIAL NUMBERS. Briggs & Stratton motors are identified by a type number, model letter and a serial number. This information is stamped on a metal plate attached to the blower housing.

64. When writing to the factory or to a Central Service Distributor for service information, or when ordering new parts, be sure to specify the type number, the model, and the serial number of the motor to be serviced. This will assure prompt and efficient service without unnecessary correspondence.

65. HOW TO MAKE OUT PARTS ORDERS. Print your name and address plainly and correctly. Do not abbreviate name of

town or state. Specify on the order how shipment to you is to be made. This will assist in giving prompt and efficient service.

66. Give part number and name of parts wanted. (Do not use number cast on parts.) You will find the part number, names and prices on pages 11 through 16, and parts illustrations on pages 17 and 18.

67. After you have made out order, check back to see that you have followed all instructions and have accurately listed what you want.

68. Shipments will be made C.O.D. or send remittance with order to cover parts and add what you think will be sufficient for postage. Send postal or express money order, bank draft or certified check for this amount. Do not send currency in a letter. It is not safe.

69. PRICES. The nearest member of our service organization will be glad to give you prices on the parts you need on request.

TO FIND THE CORRECT NUMBER OF THE PART YOU NEED

1. Make a note of your motor TYPE NUMBER (Not the Serial Number) that appears on the metal nameplate attached to motor blower housing.
2. Refer to pages illustrating parts and locate the Master Part Number by comparing your old part with the illustrations. Assemblies include all part numbers bracketed in illustrations. All parts shown in assembly brackets on which part numbers are given can be purchased separately.
3. After the Master Part Number has been identified, refer to the following Parts Lists where these Master Part Numbers are listed in numerical order.

The Master Part is used on all types of motors except those types listed under "Note."
4. If a "Note" appears below the Master Part Number this means that this part is made different from the Master Part for certain types and if your type is listed under "Note," order the part referred to.
5. If two or more parts are bracketed (—) under "Note," they are used to replace the Master Part on the type numbers shown.
6. If your motor Type Number does not appear after any part number listed under "Note," order the Master Part Number.
7. When ordering parts—or writing for service information—always specify the MODEL LETTER—TYPE NUMBER—and SERIAL NUMBER of your motor.

Parts List

Models "WI"—"WIBP"—"WR"

MASTER PART NUMBER	NAME	SHIPPING WEIGHT Lbs. Oz.
21283	Ring—Piston, Compression, Top—Standard	1
21310	Body—Breather	1
	Used on engines with inside breathers.	
21376	Ring—Piston, Compression, Top—.010" O.S.	1
21377	Ring—Piston, Compression, Top—.020" O.S.	1
21378	Ring—Piston, Compression, Top—.030" O.S.	1
21416	Bracket—Fuel Tank (Replaced by No. 22854)	
21461	Bracket—Fuel Tank (Replaced by No. 22854)	
22011	Cover—Valve	6
22020	Washer—Throttle Shaft	1
22025	Plate—Oil Baffle	6
22049	Brace—Carburetor	1
22078	Washer—Thrust—.065" Thick	1
22082	Lock—Connecting Rod Screw	1
22206	Shield—Cylinder	6
22216	Cover—Breather Valve	1
	Used on engines with inside breathers.	
22217	Shield—Oil Spray	1
	Used on engines with inside breathers.	
	Note: No. 62703 Shield—Oil Spray	1
	Used on engines with outside breathers.	
22238	Washer—Cylinder Mounting	1
22243	Washer—Cylinder Mounting	1
22247	Bushing—Cylinder	3
	Note: Used on power Take-off side of Model "WR" engines.	
22353	Washer—Valve Cover	1
22368	Washer—Control Lever	1
22372	Clamp—Casing	1
	Note: No. 22054 Clamp—Casing	1
	Used on type Nos. 25151, 25153, 95847, 95876, 95879, 95880, 95949, 95974, 96820, 96834, 96835, 96836, 96854, 96917, 96933.	
22547	Screen—Fuel Filter (Rectangular Hole) ..	1
	Note: For Screen with round hole order No. 62876	1
22725	Washer—Control Lever	1

MASTER PART NUMBER	NAME	SHIPPING WEIGHT Lbs. Oz.
22834	Washer Control Lever	1
22854	Bracket—Fuel Tank	10
22858	Bracket—Fuel Tank	10
22872	Shim—.010" Thick	1
23015	Nozzle—Carburetor	1
23056	Key— $\frac{1}{8}$ " Square	1
	Note: No. 91539 Key— $\frac{3}{8}$ " Square	1
	Used on type Nos. 95838, 95845, 95860, 96815, 96818, 96824.	
23060	Nut—Needle Valve Packing	1
23062	Bushing—Intermediate Gear	2
23068	Nut—Speed Adjusting	1
23069	Screw—Speed Adjusting	1
23075	Spacer—Foot Pedal Support	1
23077	Pinion—Starter	4
23104	Spacer—Foot Pedal Support	1
23184	Retainer—Valve Spring	1
23187	Pin—Valve Spring Retainer	1
23215	Spacer—Baffle Plate	1
23251	Stud—Carburetor Bowl	1
23443	Pin—Dowel	1
23444	Stud—Valve Cover	1
	Used on engines with inside breathers.	
	Note: No. 91707 Screw—Valve Cover ..	1
	Used on engines with outside breathers.	
23571	Swivel—Control Lever	1
23580	Bushing—Control Lever	1
23699	Nut—Fuel Shut-off Lever	1
	Used with $\frac{3}{8}$ " dia. shut-off lever.	
	Note: No. 23346 Nut—Fuel Shut-off Lever	1
	Used with $\frac{1}{8}$ " dia. shut-off lever.	
23911	Bushing—Gear Cover	2
26021	Spring—Intake Valve	1
26025	Spring—Pedal Return	1
	Note: No. 26510 Spring—Lever Return ..	1
	Used on type No. 96947.	
26026	Lock—Piston Pin	1
26032	Spring—Clutch Retainer	1
26034	Link—Governor Spring	1
	Note: No. 26117 Link—Governor Spring	1
	Used on type Nos. 95965, 95971, 95981, 96928, 96930, 96940.	
26035	Spring—Stop Pin	1

MASTER PART NUMBER	NAME	SHIPPING WEIGHT Lbs. Oz.
26050	Wire—Control—7 $\frac{1}{4}$ " Long.....	6
	Note: If longer wire is needed, specify length in inches, if shorter wire is needed, order No. 26050 and cut to required length.	
26121	Crankshaft	3
	Note: No. 26115 Crankshaft.....	3
	Used on type No. 95833.	
	No. 26127 Crankshaft.....	3
	Used on type Nos. 25175, 25177.	
	No. 26135 Crankshaft.....	3
	Used on type Nos. 95805, 95820, 95823, 95827, 95861, 95886, 95887, 96807, 96810, 96825, 96841, 96842.	
	No. 26146 Crankshaft.....	3
	Used on type Nos. 25200, 25225, 25227.	
	No. 26150 Crankshaft.....	3
	Used on type Nos. 25325, 25382, 95924, 95938, 95943, 95944, 95945, 95946, 95947, 95949, 95952, 95955, 95957, 95959, 95960, 95968, 95974, 95980, 96902, 96903, 96906, 96907, 96912, 96914, 96916, 96917, 96920, 96922, 96924, 96925, 96929, 96933, 96939, 96948.	
	No. 26177 Crankshaft.....	3
	Used on type Nos. 95825, 95831.	
	No. 26205 Crankshaft.....	3
	Used on type Nos. 95838, 95845, 95854, 95860, 95871, 95877, 96815, 96818, 96824, 96831.	
	No. 26310 Crankshaft.....	3
	Used on type Nos. 95958, 95962, 96923, 96927.	
	No. 26395 Crankshaft.....	3
	Used on type Nos. 95972, 95973, 96931, 96932.	
	No. 99312 Crankshaft.....	3
	Used on type Nos. 25100, 25103, 25104, 25105, 25106, 25107, 25108, 25109.	
	No. 99348 Crankshaft.....	3
	Used on type Nos. 25125, 25127, 25128, 25129, 25130, 25131, 25150, 25151, 25153, 25154, 25155, 25156.	
26152	Spring—Pedal and Lever Return.....	1
26172	Spring—Pump Plunger	1
26267	Spring—Control Wire Return.....	1
26328	Spring—Governor	1
	Note: No. 26111 Spring—Governor....	1
	Used on type Nos. 95965, 95971, 95981, 96928, 96930, 96940, 96946, 96947.	
26330	Spring—Breather Retainer	1
	Used on engines with inside breathers.	
26398	Link—Throttle	1
	Note: No. 62893 Link—Throttle.....	1
	Used on engines before Serial No. 348424.	
	No. 26116 Throttle—Link.....	1
	Used on type Nos. 95965, 95971, 95981, 96928, 96930, 96940, 96946, 96947.	
26478	Spring—Exhaust Valve	1
26657	Spring—Throttle Adjustment	1
27043	Gasket—Engine Base	1
	Note: Used on all engines equipped with locating dowel pins for mounting cylinder to base. On engines using eight screws for mounting cylinder to base see Part No. 68337 Gasket.	
27110	Gasket—Gear Cover—.010" Thick....	1
27111	Gasket—Gear Cover—.005" Thick....	1
27145	Packing—Fuel Shut-off Lever.....	1
	Used with $\frac{3}{8}$ " dia. shut-off lever.	
	Note: No. 27019 Packing—Fuel Shut-off Lever	1
	Used with $\frac{3}{8}$ " dia. shut-off lever.	

MASTER PART NUMBER	NAME	SHIPPING WEIGHT Lbs. Oz.
27323	Gasket—Breather Body	1
29667	Point Assembly—Contact	2
29671	Armature—Magneto	2
29693	Plug—Spark (with Gasket).....	6
29739	Piston Assembly—Standard	8
29767	Rod—Choke	1
29778	Piston Assembly—.010" Oversize....	8
29779	Piston Assembly—.020" Oversize....	8
29780	Piston Assembly—.030" Oversize....	8
29786	Sector Assembly—Starter	14
29796	Body—Carburetor	5
29801	Valve—Carburetor Choke	2
29806	Gasket—Spark Plug	1
29821	Carburetor Assembly	8
	Note: No. 29800 Carburetor Assembly	8
	Used on type Nos. 95950, 96918.	
	No. 99778 Carburetor Assembly....	8
	Used on type No. 95948.	
29829	Housing—Blower	2
	Note: No. 99426 Housing Blower.....	2
	Used on type Nos. 95965, 95971, 95981, 96928, 96930, 96940, 96946, 96947.	
29835	Flywheel—Magneto	6
29861	Condenser	2
29863	Outlet Assembly—Fuel Tank.....	2
29870	Tank Assembly—Fuel	8
	Note: No. 29034 Tank Assembly—Fuel	8
	No. 62965 Strap—Tank (2).....	3
	No. 90321 Nut—Square—10-32 (4) ..	1
	No. 90083 Screw—Machine, Rd. Hd.—10-32x $\frac{3}{8}$ " (2)	1
	No. 91366 Screw—Machine, Rd. Hd.—10-32x $\frac{7}{8}$ " (2)	1
	No. 92290 Lockwasher — No. 10x $\frac{1}{2}$ x $\frac{3}{4}$ " (4)	1
	No. 67072 Washer (2).....	1
	Used to mount No. 29034 Fuel Tank on type Nos. 95965, 95971, 95981, 96928, 96930, 96940, 96946, 96947.	
	No. 29865 Tank—Fuel.....	8
	Used on type No. 25104.	
29878	Rope—Starter	8
38852	Washer—Armature	1
61703	Gear—Cam	8
61756	Ring—Piston, Compression, Center—Standard	1
61757	Ring—Piston, Oil—Standard.....	1
61760	Key—Flywheel	1
61768	Ring—Piston, Compression, Center—.010" O.S.	1
61769	Ring—Piston, Compression, Center—.020" O.S.	1
61770	Ring—Piston, Compression, Center—.030" O.S.	1
61771	Ring—Piston, Oil—.010" O.S.....	1
61772	Ring—Piston, Oil—.020" O.S.....	1
61773	Ring—Piston, Oil—.030" O.S.....	1
61876	Bracket—Fuel Tank (Replaced by No. 22858)	
	Note: Used on carburetor side of engines equipped with base using eight mounting screws for mounting to cylinder.	
	No. 61881 Bracket—Fuel Tank..	2
	Used on type Nos. 95809, 95810, 95818, 95826, 95839, 95846, 95878, 95948, 95954.	
61944	Head—Cylinder	2
	Note: No. 21097 Head—Cylinder....	2
	Used on type Nos. 95841, 96816.	
	No. 21340 Head—Cylinder.....	2
	Used on type Nos. 95965, 95971, 95981, 96928, 96930, 96940, 96946, 96947.	
61947	Housing—Starter Clutch	1

Before ordering parts, read instructions top page 11.

MASTER PART NUMBER	NAME	SHIPPING WEIGHT Lbs. Oz.
61973	Housing—Starter Clutch	1 ..
	Note: No. 21335 Housing — Starter Clutch	14
	Used on type Nos. 95965, 96928, 96946, 96947.	
	No. 21417 Housing — Starter Clutch	14
	Used on type Nos. 95971, 96930.	
	No. 21475 Housing — Starter Clutch	14
	Used on type Nos. 95981, 96940.	
	No. 61700 Housing — Starter Clutch	1 ..
	Used on type No. 95948.	
	No. 61781 Housing — Starter Clutch	1 ..
	Used on type Nos. 95905, 95956, 96921.	
	No. 61806 Housing — Starter Clutch	1 ..
	Used on type No. 95935.	
	No. 61937 Housing — Starter Clutch	1 ..
	Used on type Nos. 95919, 95939, 96911.	
62007	Clamp—Fuel Tank	1
	Note: No. 62965 Strap—Fuel Tank... ..	3
	Used on type Nos. 95965, 95971, 95981, 96928, 96930, 96940, 96946, 96947.	
	No. 90321 Nut—Square—10-32 (4) ..	1
	No. 90083 Screw—Machine, Rd. Hd.—10-32x $\frac{3}{8}$ " (2)	1
	No. 91366 Screw—Machine, Rd. Hd.—10-32x $\frac{7}{8}$ " (2)	1
	No. 92290 Lockwasher — No. 10x $\frac{1}{8}$ x $\frac{3}{4}$ " (4)	1
	No. 67072 Washer (2).....	1
	Used to mount No. 62965 Fuel Tank Strap on blower housing on type Nos. 95965, 95971, 95981, 96928, 96930, 96940, 96946, 96947.	
62536	Cup—Starter Return Spring.....	1
62538	Washer—Clutch Retainer	1
62577	Washer—Flywheel	1
	Note: No. 62903 Washer—Flywheel.. ..	1
	Used on engines with foot or hand lever starters on blower housing side.	
62600	Stop—Starter Pedal	6
62641	Plate—Speed Adjuster Retainer.....	1
	Note: No. 62575 Spring—Speed Adjuster	1
	Used on type No. 25104.	
62651	Washer—Carburetor	1
	Note: No. 62628 Washer—Carburetor ..	1
	Used on type No. 95948.	
62693	Pulley—Rope Starter	12
62702	Washer—Choke Valve	1
62812	Bracket—Control Wire Casing.....	1
62835	Cover—Dust	8
62842	Spacer—Dust Cover	1
62891	Wrench—Spark Plug	4
62899	Washer—Needle Valve Packing.....	1
62966	Switch Stop	1
63058	Connector—Fuel Pipe	1
	Note: No. 66111 Connector—Fuel Pipe ..	1
	Used on type Nos. 95965, 95971, 95981, 96928, 96930, 96940, 96946, 96947.	
63136	Pin—Needle Valve Stop.....	1
63426	Locknut—Control Wire Casing.....	1
63699	Seat—Float Valve	1
63770	Ball—Clutch	1
63771	Bushing—Starter Sector	1
63782	Valve—Intake	2
63785	Shaft—Cam	3
63788	Tappet—Valve	1

MASTER PART NUMBER	NAME	SHIPPING WEIGHT Lbs. Oz.
63794	Pinion—Starter	4
63807	Valve—Exhaust	2
63810	Valve—Needle	1
63821	Wrench—Socket Head Screw— $\frac{1}{8}$ " ..	2
63949	Stud—Air Cleaner	1
63965	Plunger—Oil Pump	1
63967	Plug—Tank Bracket	1
65294	Washer—Fuel Tank Outlet.....	1
65304	Washer—Filler Cap	1
65534	Gasket—Filler Cap	1
65616	Casing—Control Wire 72" Long.....	8
	Note: If longer casing is needed, specify length in inches; if shorter casing is needed, order No. 65616 and cut to required length.	
65664	Washer—Float Valve Seat.....	1
65704	Plunger—Contact Point	1
65787	Gasket—Fuel Pipe Connector.....	1
65794	Insulator—Armature	1
65968	Disc—Breather Valve.....	1
	Used on engines with inside breathers.	
66114	Washer—Cylinder Mounting	1
66186	Spring—Throttle Adjusting	1
66416	Casing—Control Wire—9 $\frac{3}{4}$ " Long... ..	8
	Note: If longer casing is needed, specify length in inches; if shorter casing is needed, order No. 66416 and cut to required length.	
66432	Washer—Speed Adjuster and Control Casing	1
67307	Gasket—Magneto Plate—.015" Thick. ..	1
67316	Spring—Governor	2
67527	Gasket—Valve Cover	1
67537	Gasket—Cylinder Head	1
67597	Gasket—Magneto Plate—.005" Thick. ..	1
67607	Gasket—Magneto Plate—.009" Thick. ..	1
67617	Packing—Needle Valve	1
68122	Plug—Cam Shaft	1
68337	Gasket—Engine Base	1
	Note: Used on all engines equipped with base using eight screws for mounting to cylinder. On engines equipped with locating dowel pins for mounting cylinder to base see Part No. 27043 Gasket.	
68397	Cork	1
68437	Packing—Needle Valve	1
68467	Gasket—Carburetor Mounting	1
68477	Gasket—Fuel Filter Bowl.....	1
68487	Bowl—Fuel Filter	2
68537	Gasket—Gear Cover	1
68957	Gasket—Air Cleaner Mounting.....	1
	Note: No. 68287 Gasket—Air Cleaner Mounting	1
	Used on engines before serial No. 81165.	
69149	Float—Carburetor	4
69221	Cap—Fuel Tank	2
	Note: No. 69961 Cap—Fuel Tank.....	2
	Used on type Nos. 95965, 95971, 95981, 96928, 96930, 96940, 96946, 96947.	
69345	Cap—Oil Filler	4
89282	Carburetor Assembly	14
89291	Starter Assembly—Hand	3
	Note: No. 89443 Starter Assembly—Hand	3
	Used on type Nos. 95967, 95970, 95975, 96934, 96945.	
	No. 89485 Starter Assembly—Hand	3
	Used on type Nos. 95971, 96930.	

(See Next Page)

Before ordering parts, read instructions top page 11.

MASTER PART NUMBER	NAME	SHIPPING WEIGHT Lbs. Oz.
	No. 99430 Starter Assembly—	
	Hand	3 ..
	Used on type Nos. 95853, 95933, 95934, 95936, 95942, 95954, 95961, 95966, 95969, 95978, 95979, 96901, 96905, 96915, 96926, 96937, 96938, 96941, 96944.	
89296	Body—Carburetor	6 ..
89297	Cover—Carburetor	2 ..
89307	Valve—Oil Return	1 ..
89322	Cylinder	13 ..
	Note: On engines equipped with base using eight screws for mounting to cylinder and not otherwise listed in this "Note" use: No. 29746 Cylinder.	
	No. 29746 Cylinder.....	13 ..
	On engines equipped with locating dowel pins for mounting cylinder to base and not otherwise listed in this "Note" use: No. 89322 Cylinder.	
	No. 89089 Cylinder.....	13 ..
	Used on type Nos. 95958, 95962.	
	No. 89597 Cylinder.....	13 ..
	Used on type No. 25130.	
	No. 89608 Cylinder.....	13 ..
	Used on type Nos. 95884, 95886, 96806, 96807, 96811, 96815, 96818, 96824, 96831, 96839, 96841, 96855.	
	No. 89648 Cylinder.....	13 ..
	Used on type Nos. 96923, 96927.	
	No. 99090 Cylinder.....	13 ..
	Used on type Nos. 95804, 95805, 95813, 95821, 95823, 95825, 95829, 95831, 95838, 95845, 95850, 95854, 95860, 95864, 95871, 95878.	
	No. 99311 Cylinder.....	13 ..
	Used on type Nos. 25100, 25103, 25104, 25105, 25106, 25107, 25108, 25109, 25125, 25127, 25128, 25129, 25150, 25151, 25154, 25155, 25156.	
	No. 99750 Cylinder.....	13 ..
	Used on type Nos. 25175, 25177, 25200, 25225, 25226, 25227, 95833.	
89346	Filter Assembly—Fuel	10 ..
89347	Cover—Fuel Filter	2 ..
89409	Base—Engine	6 ..
	(Dim. "A"—3½") Oil filler nipple opposite carburetor, uses locating dowel pins for mounting cylinder to base.	
	Note: No. 89362 Base—Engine.....	6 ..
	(Dim. "A"—5½") Oil filler nipple opposite carburetor, uses locating dowel pins for mounting cylinder to base.	
	No. 89407 Base—Engine.....	6 ..
	(Dim. "A"—5½") Oil filler nipple under carburetor, uses locating dowel pins for mounting cylinder to base.	
	No. 89408 Base—Engine.....	8 ..
	(Dim. "A"—5½") Oil filler nipple opposite carburetor, magneto side starter mounting lugs, uses locating dowel pins for mounting cylinder to base.	
	No. 89436 Base—Engine.....	8 ..
	(Dim. "A"—3½") Oil filler nipple opposite carburetor, magneto side starter mounting lugs, uses locating dowel pins for mounting cylinder to base.	
	For bases using eight screws for mounting to cylinder see Master Part No. 99739 and "Notes" listed under it.	

MASTER PART NUMBER	NAME	SHIPPING WEIGHT Lbs. Oz.
89599	Blade Assembly—Governor	2 ..
	Note: No. 62598 Plate—Baffle.....	1 ..
	Used on type Nos. 95830, 95837, 95841, 96816.	
	No. 99159 Blade Assembly—	
	Governor	2 ..
	Used on type Nos. 95965, 95971, 95981, 96928, 96930, 96940.	
89612	Cover Assembly—Gear Case.....	3 ..
89660	Seal—Oil	1 ..
	Used on engines after Serial No. 308000.	
	Note: No. 23495 Ring—Oil Retainer..	1 ..
	Used on engines before Serial No. 308000.	
89677	Bushing—Cylinder or Magneto.....	4 ..
	Used on engines after Serial No. 308000.	
	Includes: No. 89660 Seal—Oil.	
	Note: No. 22247 Bushing—Cylinder	
	and Magneto	2 ..
	Used on Power Take-off side of Model "WR" engines.	
	No. 89340 Bushing—Cylinder...	3 ..
	Used on engines before Serial No. 308000.	
	Includes: No. 23495 Ring—Oil	
	Retainer.	
	No. 99158 Bearing—Ball.....	4 ..
	No. 99176 Seal—Oil.....	3 ..
	Used on Power Take-off side on type Nos. 25175, 25177, 25200, 25225, 25226, 25227, 95833.	
89966	Muffler	1 6
	Note: No. 29807 Muffler.....	6 ..
	Used on type Nos. 95950, 96918.	
	No. 99866 Muffler.....	1 6
	Used on type Nos. 95809, 95911, 95928, 95976, 95977, 96808, 96935, 96936.	
90066	Screw—Machine—Rd. Hd.—8-32x¼" ..	1 ..
90067	Screw—Machine—Rd. Hd.—8-32x⅜" ..	1 ..
90081	Screw—Machine—Rd. Hd.—10-32x½" ..	1 ..
90202	Screw—Machine—Fill. Hd.—10-32x½" ..	1 ..
90313	Nut—Hex.—8-32	1 ..
90355	Nut—Hex.—10-32	1 ..
90364	Lockwasher—No. 8x⅜x⅜"	1 ..
90366	Lockwasher—⅝x⅜x⅜"	1 ..
90367	Lockwasher—No. 8x⅜x⅜"	1 ..
	Note: No. 90364 Lockwasher—No.	
	8x⅜x⅜"	1 ..
	Used on carburetor on type Nos. 95948, 95950.	
90528	Screw—Magneto Mounting	1 ..
	Note: No. 92134 Screw—Magneto	
	Mounting	1 ..
	Used on type No. 96947.	
90733	Pin—Cotter—½x1¼"	1 ..
90781	Screw—Machine—Fill. Hd.—8-32x⅜" ..	1 ..
90832	Lockwasher—¼x⅜x⅜"	1 ..
90847	Nut—Hex.—¼-28	1 ..
	Used on engines with inside breathers.	
90916	Screw—Machine, Rd. Hd.—¼-20x½" ..	1 ..
	Note: No. 90916 Screw—Machine, Rd.	
	Hd.—¼-20x½"	1 ..
	No. 90832 Lockwasher—	
	¼x⅜x⅜"	1 ..
	Used to mount Blower Housing to Cylinder Head on type Nos. 95965, 95971, 95981, 96928, 96930, 96940, 96946, 96947.	
90950	Screw—Cap, Hex. Hd.—⅝-24x¾"	1 ..
91070	Lockwasher—Shakeproof No. 1208...	1 ..
91084	Plug—Pipe—⅜"	1 ..
91208	Nut—Hex.—⅜-24	1 ..
91237	Lockwasher—¼x⅜x⅜"	1 ..

Before ordering parts, read instructions top page 11.

MASTER PART NUMBER	NAME	SHIPPING WEIGHT Lbs. Oz.
91253	Screw—Machine, Fill. Hd.—6-32x $\frac{1}{8}$ "	1
91321	Screw—Machine, Rd. Hd.— $\frac{1}{4}$ -20x $\frac{3}{8}$ "	1
91324	Washer— $\frac{1}{4}$ " Standard	1
91359	Screw—Machine, Fill Hd.—10-32x $\frac{3}{4}$ "	1
	Note: { No. 62890 Washer—Carb. Mtg.	
	{ No. 92013 Screw—Machine,	
	Fill. Hd.—10-32x $\frac{1}{8}$ "	
	Used on type Nos. 95965, 95971, 95981, 96928, 96930, 96940, 96946, 96947.	
91401	Screw—Machine, Fill. Hd.—8-32x $\frac{1}{4}$ "	1
91413	Pin—Cotter— $\frac{1}{8}$ x1"	1
91419	Screw—Cap, Hex. Hd.— $\frac{1}{4}$ -20x $\frac{3}{8}$ "	1
	Used to mount oil pump to base on engines equipped with locating dowel pins for mounting cylinder to base.	
91488	Plug—Pipe— $\frac{1}{8}$ "	1
	Note: No. 90878 Plug—Pipe— $\frac{1}{4}$ "	1
	Used on engines with $\frac{1}{4}$ " pipe tapped oil drain hole in base.	
91541	Screw—Cap, Hex. Hd.— $\frac{5}{8}$ -24x $\frac{3}{8}$ "	1
91635	Connector—Fuel Filter	1
91636	Screw—Set, Socket Head, Cup Point— $\frac{5}{8}$ -24x $\frac{3}{8}$ "	1
	Note: No. 91758 Screw—Set, Socket Head, Cone Point— $\frac{5}{8}$ -24x $\frac{1}{2}$ "	1
	Used on type Nos. 95804, 95810, 95821, 95822, 95836, 96806, 96811, 96814.	
91700	Nut—Hex.— $\frac{1}{4}$ -20	1
91708	Nut—Flywheel	1
	Note: No. 91900 Nut—Flywheel	1
	Used on engines with foot or hand lever starter on blower housing side.	
91711	Screw—Cylinder Head	1
	Note: { No. 63337 Spacer	1
	{ No. 68873 Spacer	1
	{ No. 91203 Screw—Cylinder Hd.	1
	Used to mount cylinder head on blower housing side on type Nos. 25151, 25153, 95847, 95949, 95974, 96820, 96917, 96933.	
	No. 91386 Screw—Cylinder Head	1
	Used on type Nos. 95967, 95970, 95975, 96934, 96945.	
91741	Screw—Pedal Return Spring Cup	1
91753	Screw—Machine, Fill. Hd.—8-32x1"	1
91758	Screw—Set, Socket Hd.— $\frac{5}{8}$ -24x $\frac{1}{2}$ "	1
91787	Screw—Cap, Hex. Hd.— $\frac{1}{4}$ -28x2"	1
91796	Screw—Cap, Hex. Hd.— $\frac{5}{8}$ -24x $\frac{1}{4}$ "	1
	Note: { No. 91207 Screw—Cap, Hex. Hd.— $\frac{5}{8}$ -24x2"	1
	{ No. 62266 Washer	1
	Used on top two holes in gear case on type No. 25153.	
91805	Screw—Cap, Hex. Hd.— $\frac{1}{8}$ -20x1"	1
91807	Screw—Machine, Rd. Hd.— $\frac{1}{4}$ -20x $\frac{3}{4}$ "	1
91808	Lockwasher— $\frac{1}{8}$ x $\frac{3}{2}$ x $\frac{1}{8}$ "	1
91810	Elbow—Exhaust	6
	Note: { No. 61755 Elbow—Exhaust	6
	{ No. 63783 Fitting—Exhaust Elbow	2
	Used on type Nos. 95948, 95950, 96918.	
	No. 91812 Elbow—Exhaust	6
	Used on type Nos. 95809, 95828, 95853, 96808, 96813, 96847, 96853, 96941.	
	No. 91960 Elbow—Exhaust	6
	No. 91258 Nipple—Exhaust	3
	Used on type Nos. 95933, 95979, 96938.	
91811	Locknut—Exhaust Elbow	2
91833	Stud—Dust Cover	1
91846	Screw—Machine, Fill. Hd.—8-32x $\frac{3}{4}$ "	1

MASTER PART NUMBER	NAME	SHIPPING WEIGHT Lbs. Oz.
91901	Screw—Cap, Hex. Hd.— $\frac{1}{8}$ -20x $\frac{1}{2}$ "	1
92000	Screw—Cap, Hex. Hd.— $\frac{1}{4}$ -28x $\frac{1}{4}$ "	1
	Note: No. 91183 Screw—Cap, Hex. Hd.— $\frac{1}{4}$ -28x $\frac{3}{8}$ "	1
	Used on engines before Serial No. 49477.	
92067	Nut—Wing	1
92129	Nut—Hex.— $\frac{1}{4}$ -28	1
92227	Lockwasher—Shakeproof No. 1120	1
92235	Screw—Cylinder Mounting	1
92236	Screw—Cylinder Mounting	1
	Note: No. 92249 Screw—Cap, Hex. Hd.— $\frac{3}{8}$ -24x $\frac{1}{2}$ "	1
	Used on earlier models of type Nos. 25130, 95872, 95883, 95969, 95970, 95975, 95978, 95979, 96938.	
92285	Pin—Cotter—No. 18x $\frac{1}{4}$ "	1
92287	Screw—Machine, Rd. Hd.—10-32x $\frac{1}{4}$ "	1
92290	Lockwasher—No. 10x $\frac{1}{16}$ x $\frac{3}{8}$ "	1
92305	Washer—Control Lever	1
92306	Screw—Cap, Hex. Hd.— $\frac{1}{4}$ -20x $\frac{5}{8}$ "	1
	Note: { No. 90802 Screw—Cap, Hex. Hd.— $\frac{1}{4}$ -20x $\frac{1}{2}$ "	1
	{ No. 92278 Nut—Hex.— $\frac{1}{4}$ -20	1
	Used to mount control lever to lever base on type Nos. 95908, 96808.	
92324	Rivet—Tubular— $\frac{1}{8}$ x $\frac{3}{2}$ "	1
92427	Connector—Fuel Pipe	1
92604	Screw—Connecting Rod	1
	Note: No. 91849 Screw—Connecting Rod	1
	Used on engines before Serial No. 108719.	
92634	Screw—Machine, Rd. Hd.—5-40x $\frac{5}{8}$ "	1
99023	Cleaner Assembly—Air	8
	Note: No. 89281 Cleaner—Air	5
	Used on type Nos. 95965, 95971, 95981, 96928, 96930, 96940, 96946, 96947.	
99098	Wire—Choke Control	6
	Note: No. 29228 Wire—Choke Control	6
	Used on type Nos. 95814, 95850, 95852, 95866, 95872, 95883, 95912, 95969, 95978.	
	No. 99643 Wire—Choke Control	6
	Used on type Nos. 95821, 96811.	
99099	Pipe—Fuel— $\frac{1}{2}$ " Dia. x 5" Long	4
	Note: No. 69002 Pipe—Fuel— $\frac{3}{8}$ " Dia. x 4 $\frac{1}{2}$ " Long	3
	Used on type Nos. 95965, 95971, 95981, 96928, 96930, 96940, 96946, 96947.	
	For other lengths of $\frac{1}{2}$ " dia. Fuel Pipes specify:	
	No. 29243 Pipe—Fuel—10" Long	4
	No. 29411 Pipe—Fuel—13" Long	4
	No. 29826 Pipe—Fuel—25 $\frac{1}{2}$ " Long	6
	No. 29858 Pipe—Fuel—21" Long	6
	No. 29919 Pipe—Fuel—18" Long	4
	No. 64419 Pipe—Fuel—9" Long	4
	No. 64499 Pipe—Fuel—12" Long	4
	No. 69324 Pipe—Fuel—6" Long	4
	No. 69339 Pipe—Fuel—14" Long	4
	No. 69357 Pipe—Fuel—40" Long	6
	No. 69404 Pipe—Fuel—16" Long	4
	No. 99095 Pipe—Fuel—20" Long	4
99103	Pedal—Foot Starter	1
	Note: No. 29704 Pedal—Foot Starter	1
	Used on type Nos. 95909, 95922.	
	No. 29879 Pedal—Foot Starter	1
	Used on type Nos. 95950, 96918.	
	No. 29882 Pedal—Foot Starter	1
	Used on type No. 95939.	
	No. 29921 Pedal—Foot Starter	1
	Used on type No. 95912.	
	No. 99666 Pedal—Foot Starter	1
	Used on type No. 95948.	

Before ordering parts, read instructions top page 11.

MASTER PART NUMBER	NAME	SHIPPING WEIGHT Lbs. Oz.
99104	Starter Assembly—Foot	3 ..
	Note: No. 29804 Starter Assembly—Foot	3 ..
	Used on type No. 95939.	
	No. 29809 Starter Assembly—Foot	3 ..
	Used on type Nos. 95909, 95922.	
	No. 29880 Starter Assembly—Foot	3 ..
	Used on type Nos. 95950, 96918.	
	No. 29920 Starter Assembly—Foot	3 ..
	Used on type No. 95912.	
	No. 99660 Starter Assembly—Foot	3 ..
	Used on type No. 95948.	
99106	Elbow—Air Cleaner	6 ..
99165	Valve—Needle	3 ..
99272	Clutch Assembly—Starter	1 ..
99288	Cable—Ignition	2 ..
99291	Breather, Outside	1 ..
	Note: No. 99597 Breather—Outside ..	1 ..
	Used on earlier model "WR" engines.	
99306	Pedal—Starter	1 ..
99307	Starter Assembly—Foot	3 ..
99313	Gear—Intermediate	1 ..
	Note: No. 89123 Gear—Intermediate ..	1 ..
	Used on type Nos. 25105, 25127, 25128, 25154, 25155.	
99314	Drive Shaft Assembly	2 ..
	Note: No. 89121 Drive Shaft Assembly ..	2 ..
	Used on type Nos. 25105, 25127, 25128, 25154, 25155.	
	No. 89174 Drive Shaft Assembly ..	2 ..
	Used on type Nos. 25129, 25130, 25153.	
99317	Seal—Oil	4 ..
99320	Control Assembly—Throttle	6 ..
99339	Starter Assembly—Hand	3 ..
99349	Clutch Assembly—Starter	1 ..
	Note: No. 29741 Clutch Assembly—Starter	1 ..
	Used on type No. 95948.	
	No. 29853 Clutch Assembly—Starter	1 ..
	Used on type Nos. 95905, 95956, 96921.	
	No. 29951 Clutch Assembly—Starter	1 ..
	Used on type No. 95935.	
	No. 89275 Clutch Assembly—Starter	1 ..
	Used on type Nos. 95965, 96928, 96946, 96947.	
	No. 89476 Clutch Assembly—Starter	2 ..
	Used on type Nos. 95971, 96930.	
	No. 89665 Clutch Assembly—Starter	2 ..
	Used on type Nos. 95981, 96940.	
	No. 99226 Clutch Assembly—Starter	1 ..
	Used on type Nos. 95919, 95939, 96911.	
99588	Lever Assembly—Throttle	2 ..
99630	Cleaner—Air	1 ..
99632	Tooth Assembly—Spring	1 ..
99640	Rod Assembly—Connecting	8 ..
99665	Yoke—Fuel Filter	2 ..
99739	Base—Engine	6 ..
	Square mounting lugs, oil filler nipple on power take-off side, with eight holes for mounting to cylinder.	
	Note: No. 99736 Base—Engine	8 ..
	Square mounting lugs, magneto side starter mounting lugs, with eight holes for mounting to cylinder.	
	No. 99740 Base—Engine	8 ..
	Square mounting lugs, oil filler nipple on magneto side, with eight holes for mounting to cylinder.	

MASTER PART NUMBER	NAME	SHIPPING WEIGHT Lbs. Oz.
	No. 99743 Base—Engine	8 ..
	Square mounting lugs, oil filler nipple on magneto side, magneto side starter mounting lugs, with eight holes for mounting to cylinder.	
99764	Support Assembly—Foot Pedal	6 ..
99765	Lever and Support Assembly—Hand ..	2 ..
99874	Adjuster—Speed	1 ..
99955	Pump Assembly—Oil	1 ..
290059	Lever—Fuel Shut-off, 3/8" Dia. "T" Shaped	2 ..
	Note: No. 23347 Lever—Fuel Shut-off, 3/8" Dia. "L" Shaped	2 ..
290400	Pulley—Drive, V-Belt, 2" Dia.	1 ..
	Note: No. 29913 Pulley—Drive, V-Belt, 1 1/8" Dia.	8 ..
	Mounted on blower housing side on type Nos. 95907, 95917, 95942, 96915.	
	No. 63991 Pulley—Drive, V-Belt, 2" Dia.	1 ..
	Used on type Nos. 95810, 95822, 95836, 96814.	
	No. 99079 Pulley—Drive, V-Belt, 2 3/8" Dia.	1 ..
	Used on type Nos. 95804, 95821, 95864, 95882, 95884, 96806, 96811, 96839.	
290413	Cap—Oil Filler	4 ..
290548	Breather Assembly	2 ..
290568	Lever Assembly—Control (Stamped Steel)	4 ..
	Note: No. 29035 Lever Assembly—Control	1 ..
	Used on type Nos. 95809, 96808.	
	No. 89583 Lever Assembly—Control (Cast Iron)	1 ..
	Used on type Nos. 95841, 96816.	
	No. 92282 Screw	1 ..
	Includes: No. 92289 Screw — Clamp (2)	1 ..
290584	Base—Control Lever (Stamped Steel) ..	2 ..
	Note: No. 21441 Base—Control Lever ..	6 ..
	Used on type Nos. 95841, 96816.	
	No. 65631 Base—Control Lever ..	6 ..
	Used on type Nos. 95809, 96808.	
290642	Lever—Control (Stamped Steel)	2 ..
290792	Plate—Magneto	2 ..
	Note: No. 290869 Plate—Magneto	2 ..
	Used on type Nos. 25128, 95801, 95901, 95938, 95940, 95946, 95960, 95965, 95971, 95972, 95980, 95981, 96804, 96808, 96847, 96914, 96925, 96928, 96930, 96931, 96939, 96940, 96946, 96947.	
290893	Magneto Assembly	6 ..
	Note: No. 290772 Magneto Assembly ..	6 ..
	Used on type Nos. 95965, 95981, 96928, 96940, 96946, 96947.	
	No. 42215 Connector	1 ..
	Includes: No. 66115 Wire — Ground	1 ..
	No. 290894 Magneto Assembly ..	6 ..
	Used on type Nos. 95971, 96930.	
	No. 42215 Connector	1 ..
	Includes: No. 66195 Wire — Ground	1 ..
	No. 290895 Magneto Assembly ..	6 ..
	Used on type Nos. 25128, 95801, 95901, 95938, 95940, 95946, 95960, 95972, 95980, 96804, 96808, 96847, 96914, 96925, 96931, 96939.	
	Includes: No. 66155 Wire — Ground	1 ..
	No. 290896 Magneto Assembly ..	6 ..
	Used on type Nos. 95830, 95837, 95841, 96816.	
290918	Lever Assembly—Control	3 ..
290980	Pin Assembly—Piston—Standard	2 ..
290981	Pin Assembly—Piston—.005" O.S.	2 ..

Before ordering parts, read instructions top page 11.

Plate No. 19
Gear Reduction Parts

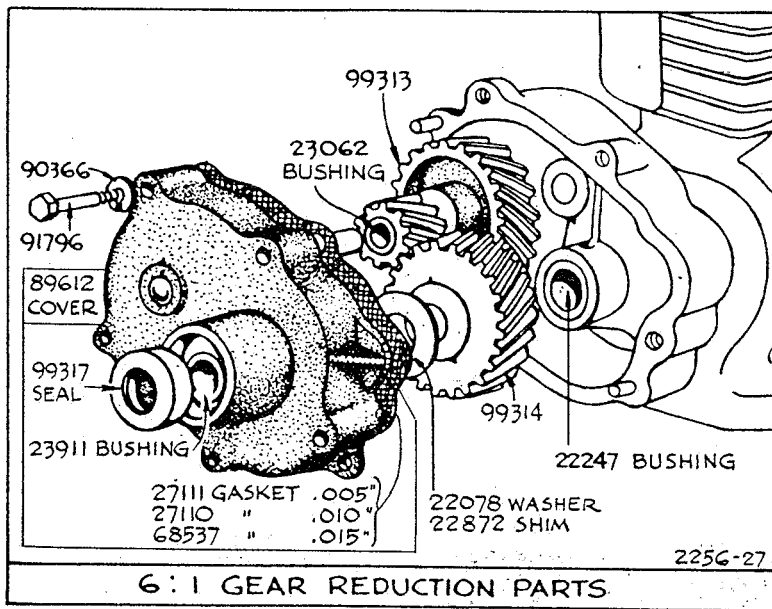

ABOVE PARTS LISTED ON PAGE 11 THROUGH 16

NATION-WIDE SERVICE ORGANIZATION

To provide prompt and efficient service on Briggs & Stratton motors, Authorized Central Service Distributors and Motor Service Stations are located in the principal cities of the United States and Canada.

Each Authorized Service Organization carries a complete stock of original Briggs & Stratton repair parts. Each is equipped with special factory service tools and factory-trained mechanics, assuring expert repair service on all Briggs & Stratton motors.

All Authorized Service Organizations are instructed by the factory to replace free of charge all parts found to be defective in either material or workmanship, according to the conditions of the Briggs & Stratton Guarantee.

All gratis work done under the warranty is the responsibility of the Authorized Service Organization until all the material involved and supporting facts are submitted to and approved by the factory.

In a difference of opinion regarding a Service Organization's decision, their terms should be accepted and, either through them or direct, have all materials and supporting facts submitted to the factory for review.

Genuine Briggs & Stratton service will assure continuous motor satisfaction. Our long experience in motor maintenance prompts us to urge that all service work be done by an Authorized Service Organization or at our factory. Mechanics unfamiliar with Briggs & Stratton products, or without proper tools, should not be permitted to make major repairs.

Parts and repair work are F. O. B. Factory or any Authorized Briggs & Stratton Central Service Distributor, or Motor Service Station. The Central Service Distributor nearest you (see list below) will be glad to give you the name of our Motor Service Station in your locality. Space does not permit listing here.

Authorized Central Service Distributors

STATE	CITY	NAME	LOCATION
Alabama	Birmingham 3	Birmingham Electric Battery Co.	Ave. B, at 23rd St.
Arizona	Phoenix	Motor Supply Co.	402-414 N. Central Ave.
California	Los Angeles 15	Electric Equipment Co.	1611 S. Hope St.
California	San Francisco 3	Frank Edwards Co., Automotive Service Div.	382-4 Sixth St.
Colorado	Denver 1	Spitzer Electrical Company	43 W. 9th Ave.
Florida	Jacksonville 1	Spencer Electric, Inc.	40 W. Beaver St.
Florida	Miami 32	Electrical Equipment Co.	42-58 N. W. 4th St.
Florida	Tampa 1	Spencer Auto Electric, Inc.	607-11 E. Cass St.
Georgia	Atlanta 3	Auto Electric & Magneto Co.	477 Spring St., N. W.
Illinois	Chicago 16	Mid-States Auto Electric Co.	1905 S. Michigan Ave.
Indiana	Indianapolis 1	Gulling Auto Electric Co.	450 N. Capitol Ave.
Iowa	Des Moines 9	Magneto Carburetor & Electric Co., Inc.	1308 Grand Ave.
Kansas	Wichita 2	The E. S. Cowie Electric Co.	230 S. Topeka Ave.
Kentucky	Lexington 34	Kentucky Ignition Co., Incorporated	Rose and Vine Sts.
Louisiana	New Orleans 1	A. C. Suhren Company	1319 St. Charles Ave.
Louisiana	Shreveport 80	Chain Battery & Automotive Supply, Inc.	Marshall at Cotton St.
Massachusetts	Boston 15	Wm. H. Flaherty Co.	48-52 Cummington St.
Michigan	Detroit 1	Auto Electric & Service Corporation	90 Selden Ave.
Minnesota	Minneapolis 2	Reinhard Brothers Co., Inc.	11 S. Ninth St.
Missouri	Kansas City 8	The E. S. Cowie Electric Co.	1819 Wyandotte St.
Missouri	St. Louis 3	Medart Auto Electric Co., Inc.	3134 Washington Blvd.
Montana	Billings	Original Equipment, Inc.	423 N. Broadway
Nebraska	Lincoln 8	Carl A. Anderson, Inc.	1637 P Street
Nebraska	Omaha 2	Carl A. Anderson, Inc.	16th and Jones Sts.
New Mexico	Albuquerque	Spitzer Electrical Co.	3rd and Mountain Rd.
New York	Buffalo 14	The Battery & Starter Co., Inc.	2505 Main St.
New York	New York 23	The Durham Co., Inc.	606 W. 49th St.
New York	Syracuse 4	F. A. Crossman, Inc.	943 W. Genesee St.
North Carolina	Charlotte 1	Carolina Rim & Wheel Co.	312 N. Graham St.
North Dakota	Fargo	Reinhard Brothers, Inc.	301 N. Pacific Ave.
Ohio	Cincinnati 2	Gardner, Inc.	1847 Reading Road
Ohio	Cleveland 15	The Electric Power Maintenance Co.	Prospect at E. 30th
Ohio	Toledo 1	The Electric Power Maintenance Co.	26-30 Seventeenth St.
Oklahoma	Oklahoma City 2	American Electric Ignition Co.	124 N. W. 8th St.
Oregon	Portland 9	Tracey & Co., Inc.	N. W. 10th and Glisan
Pennsylvania	Philadelphia 30	Auto Equipment & Service Co., Inc.	1522-24 Fairmount Ave.
Pennsylvania	Pittsburgh 24	Pitt Auto Electric Company	5135 Baum Blvd.
South Dakota	Aberdeen	Reinhard Brothers Co., Inc.	317 S. Lincoln St.
South Dakota	Sioux Falls	Reinhard Bros. Co., Inc.	225 E. 11th St.
Tennessee	Knoxville 7	R. T. Clapp Company	401-7 N. Broadway
Tennessee	Memphis 4	Automotive Electric Service Co.	982 Linden Ave.
Texas	Amarillo	The E. S. Cowie Electric Co.	700 Van Buren St.
Texas	Dallas 1	Beard & Stone Electric Co., Inc.	3909 Live Oak St.
Texas	El Paso	Motor Supply Co.	308 Chihuahua St.
Texas	Houston 1	Beard & Stone Electric Company, Inc.	Milam at Polk Ave.
Texas	San Antonio 6	S. X. Callahan	425 N. Flores St.
Utah	Salt Lake 13	Frank Edwards Co., Motor Equipment Div.	551 So. State St.
Virginia	Richmond	Richmond Battery & Ign. Co.	2912 W. Leigh St.
Washington	Seattle 14	Sunset Electric Co.	300 Westlake North
Washington	Spokane	Sunset Electric Co.	N. 703 Division St.
Wisconsin	Milwaukee 2	Wisconsin Magneto Co.	918 N. Broadway
DOMINION OF CANADA			
Manitoba	Winnipeg	Beattie Auto Electric Limited	176 Fort St.
Ontario	Toronto-5	Auto Electric Service Company Limited	1009-27 Bay St.

Only Authorized Service Organizations
Display this Sign -



Your Assurance of Efficient
Briggs & Stratton Service

BRIGGS & STRATTON CORP., • MILWAUKEE 1, WIS., U. S. A.

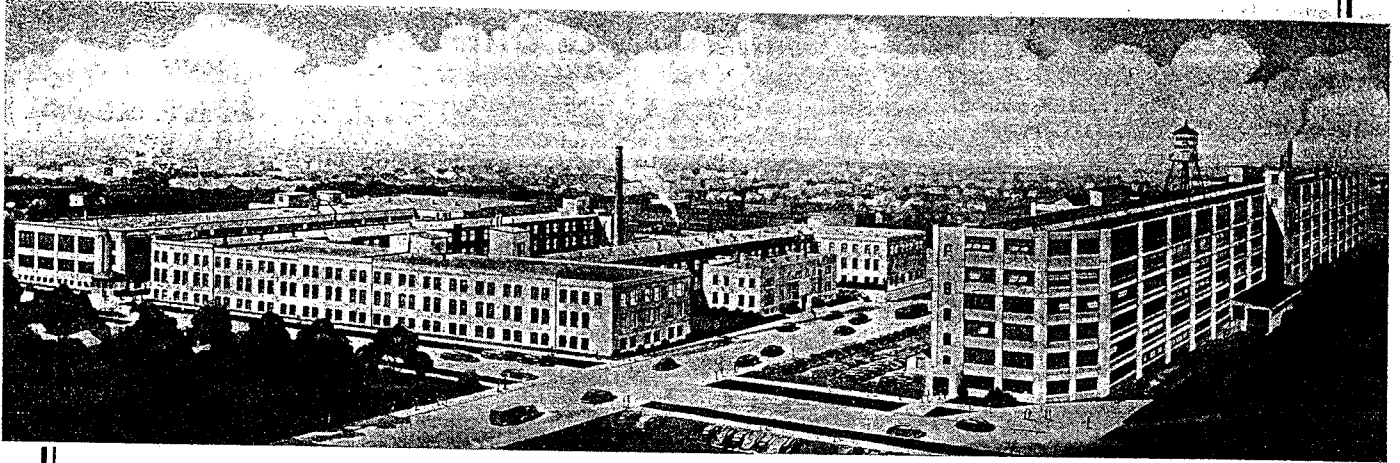

WHERE BRIGGS AND STRATTON MOTORS
ARE MADE

THESE large and modern factory buildings, located in Milwaukee, Wisconsin, are complete with all modern equipment and machinery for precision construction, economical production, rigid inspection and thorough testing of Briggs & Stratton 4-cycle gasoline motors.

Briggs & Stratton Corp. produces more small 4-cycle air-cooled gasoline motors than any other manufacturer in the world.

BRIGGS & STRATTON CORP., MILWAUKEE 1, WIS.

